

Features

- PIN Diode SP3T Reflective design
- Frequency: 2-20GHz
- Isolation: 48dB Typical
- Insertion Loss: 0.9 dB Typical
- Control Voltage: +5/-5V
- Switching Speed: 20 ns Typical
- Die Size: 2.0 x 1.7 x 0.1 mm

Typical Applications

- Voltage control
- Fast Switching Speed
- Low Insertion Loss and High Isolation
- Customization available upon request

Functional Block Diagram

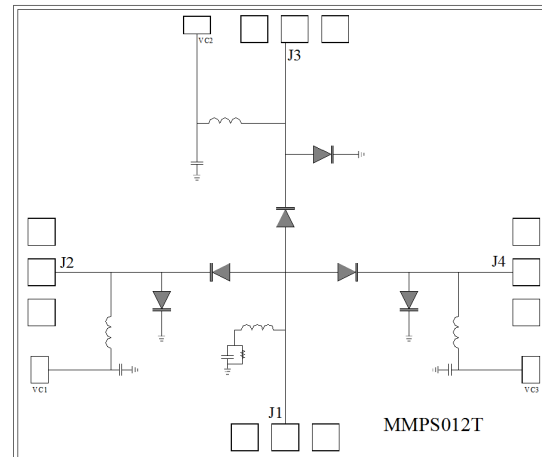

Electrical Specifications

TA = +25°C, VCTL=+5/-5V , +12mA /-10mA Typical

Parameters	Min.	Typ.	Max.	Units
Frequency	2		20	GHz
Insertion Loss		0.7	1.2	dB
Isolation		48		dB
Input Return Loss (ON State)		15		dB
Output Return Loss (OFF State)		15		dB
P1dB - Output 1dB Compression		26		dBm
IIP3-Input Third Order Intercept		40		dBm
Switching Speed		20		ns



Insertion Loss vs. Frequency

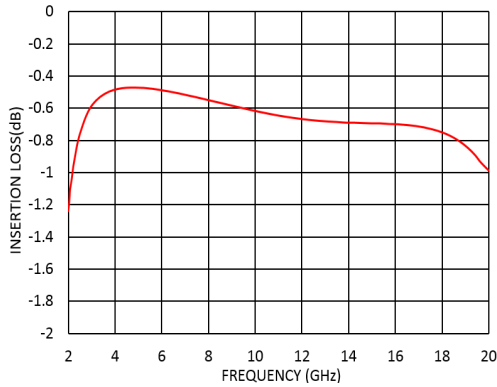

Isolation vs. Frequency

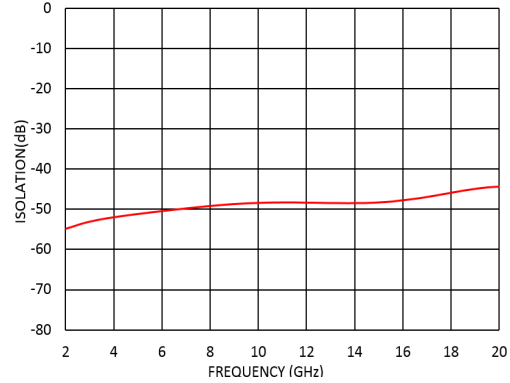

Input Return Loss vs. Frequency

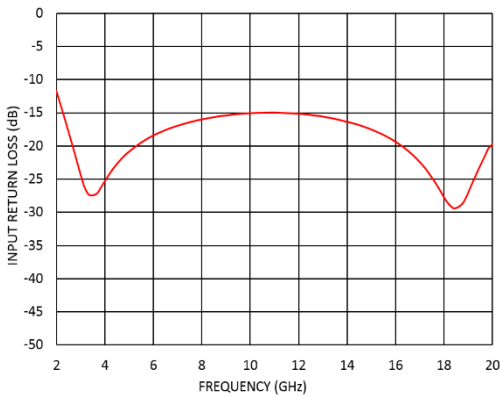

Output Return Loss vs. Frequency

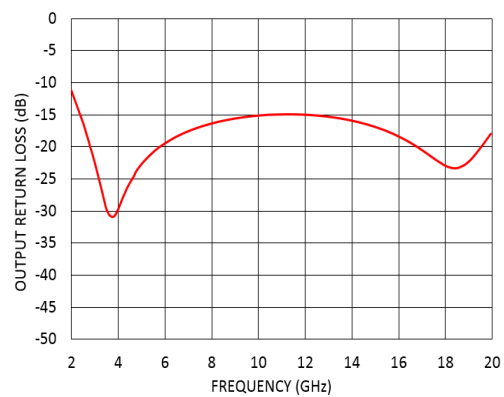



Absolute Maximum Ratings

Max Incident C.W. RF Power	+31dBm
DC Reverse Voltage	25V
Bias Current	±50 mA
Operating Temperature	-55°C to +85 °C
Storage Temperature	-65°C to +150 °C



ELECTROSTATIC SENSITIVE DEVICE
OBSERVE HANDLING PRECAUTIONS

Outline Drawing: All Dimensions in μm

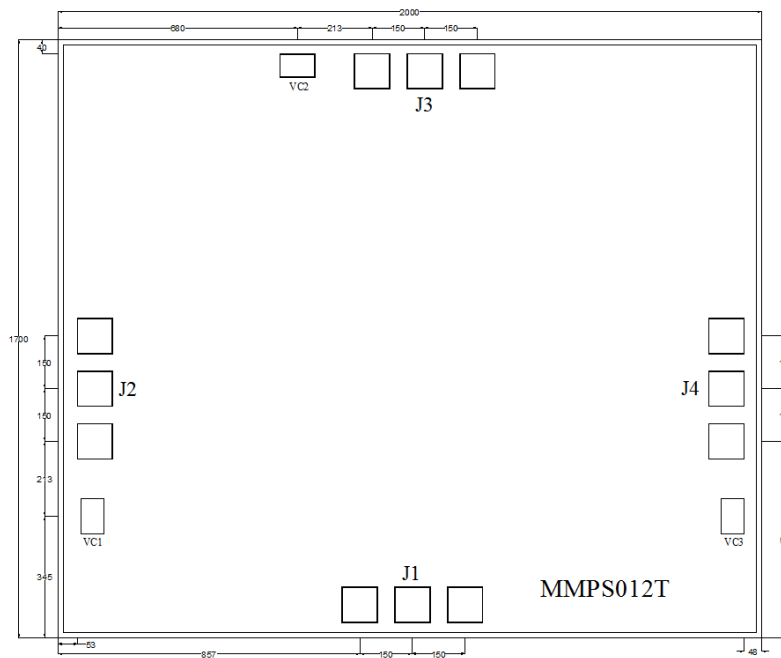

True Table

Control Voltage			State		
VC1	VC2	VC3	J2→J1	J3→J1	J4→J1
-5V	+5V	+5V	ON	OFF	OFF
+5V	-5V	+5V	OFF	ON	OFF
+5V	+5V	-5V	OFF	OFF	ON



Assembly Drawing

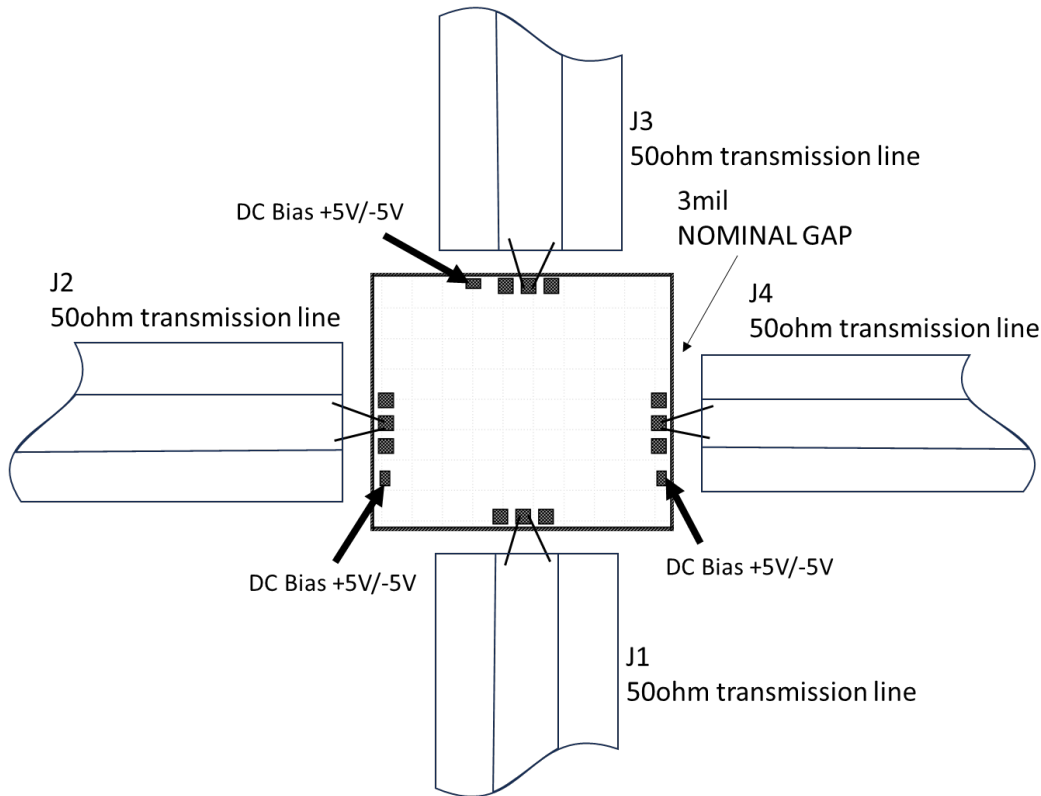

Notes:

1. Die thickness: 100 μ m
2. Typical bond pad is 100*100 μ m²
3. Bond pad metallization: Gold
4. Backside metallization: Gold
5. Backside of the die (GND)
6. No connection required for unlabeled bond pads

Miller MMIC Inc. All rights reserved

Miller MMIC, Inc. holds exclusive rights to the information presented in its Data Sheet and any accompanying materials. As a premier supplier of cutting-edge RF solutions, Miller MMIC has made this information easily accessible to its clients.

Although Miller MMIC believes the information provided in its Data Sheet to be trustworthy, the company does not offer any guarantees as to its accuracy. Therefore, Miller MMIC bears no responsibility for the use of this information. It is worth mentioning that the information within the Data Sheet may be altered without prior notification.

Customers are encouraged to obtain and verify the most recent and pertinent information before placing any orders for Miller MMIC products. The information in the Data Sheet does not confer, either explicitly or implicitly, any rights or licenses with regards to patents or other forms of intellectual property to any third party.

The information provided in the Data Sheet, or its utilization, does not bestow any patent rights, licenses, or other forms of intellectual property rights to any individual or entity, whether in regards to the information itself or anything described by such information. Furthermore, Miller MMIC products are not intended for use as critical components in applications where failure could result in severe injury or death, such as medical or life-saving equipment, or life-sustaining applications, or in any situation where failure could cause serious personal injury or death.