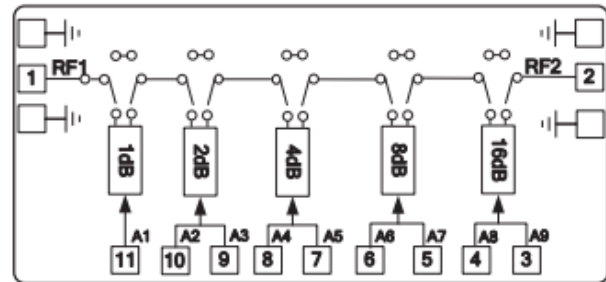

Features

- Attenuation Range: 1dB – 31dB
- Attenuation Accuracy: $\pm 0.3\text{dB}$
- Insertion Loss : 5.1dB
- Attenuation Additional Phase Shift: $\pm 4^\circ$
- Impedance: 50 Ω
- Die Size: 2.5 x 1.0 x 0.1 mm

Typical Applications

- Test Instrumentation
- Microwave Radio & VSAT
- Military & Space
- Telecom Infrastructure
- Fiber Optics

Functional Block Diagram

Electrical Specifications
TA = +25°C, Vctl = 0/-5V

Parameters	Min.	Typ.	Max.	Units
Frequency	0.5-18			GHz
Insertion Loss		5.1		dB
Attenuation Range	1		31	dB
Return Loss (Direct State)		16		dB
Return Loss (Attenuation State)		15		dB
Input 1dB Compression (P1dB)		24		dBm
Switching Speed		30		ns

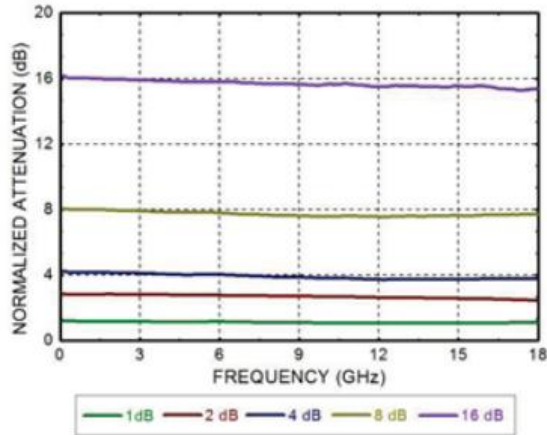

Attenuation



Relative Phase vs. Frequency

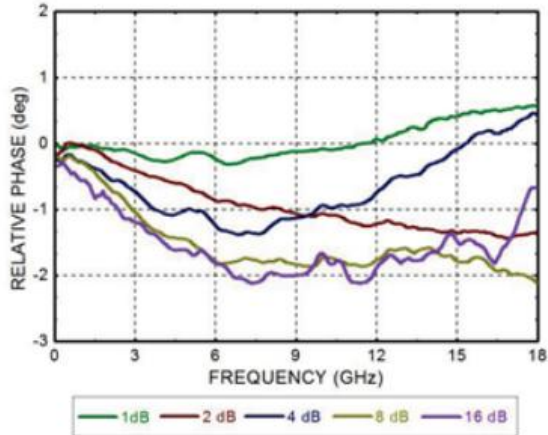

Insertion Loss

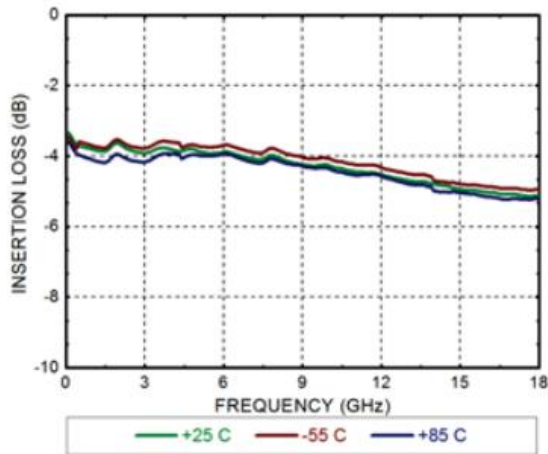

Return Loss

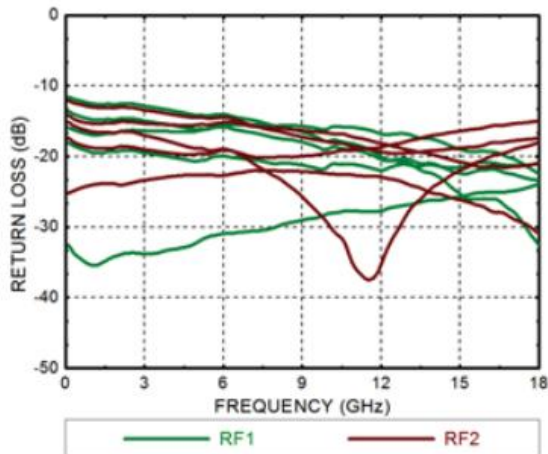



Outline Drawing:

All Dimensions in mm

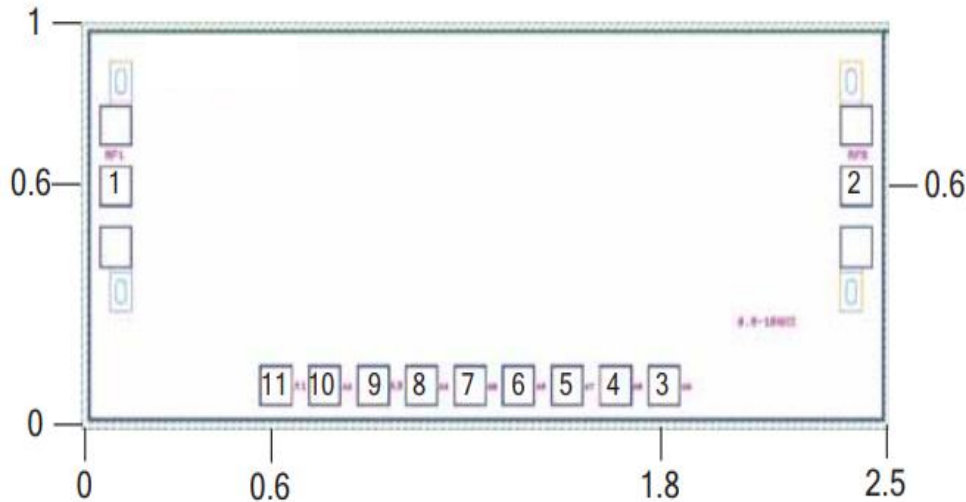

Pad Description

PAD	Function	Description
1	RF1	This pad is RF port and matched to 50Ω Impedance
2	RF2	This pad is RF port and matched to 50Ω Impedance
3, 4	A9, A8	A9=-5V, A8=0V pass-through ; A9=0V, A8=-5V decaying 16dB
5, 6	A7, A6	A7=-5V, A6=0V pass-through ; A7=0V, A6=-5V decaying 8dB
7, 8	A5, A4	A5=-5V, A4=0V pass-through ; A5=0V, A4=-5V decaying 4dB
9, 10	A3, A2	A3=-5V, A2=0V pass-through ; A3=0V, A2=-5V decaying 2dB
11	A1	A1=-5V pass-through ; A1=0V decaying 1dB
Die Bottom	GND	Die bottom must be connected to RF/DC ground



Assembly Drawing

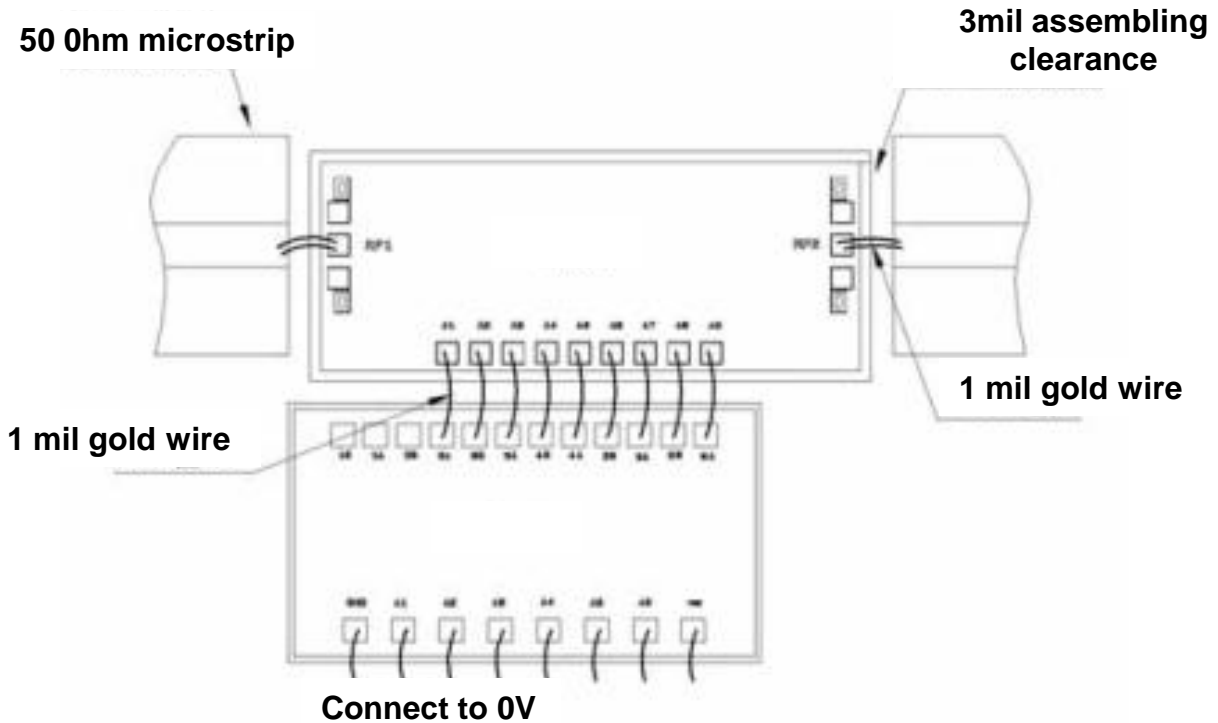

Notes:

1. Die thickness: 100um
2. Typical bond pad is 100*100 μm²
3. Bond pad metalization: Gold
4. Backside metalization: Gold
5. Backside of the die (GND)
6. No connection required for unlabeled bond pads

Maximum Ratings:

1. RF input power: +24dBm
2. Storage temperature: -65°C to +175°C
3. Operating temperature: -55°C to +85°C