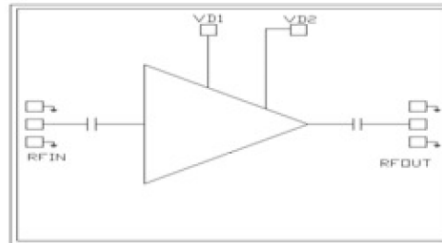

Features

- Frequency: 6-18GHz
- Small Signal Gain: 16.5dB
- P1dB: 27.5dBm
- Psat: 28.5dBm
- Power Supply: +10V/340mA
- Input/Output: 50Ω
- Die Size: 1.85 x 2.28 x 0.1 mm

Functional Block Diagram

Typical Applications

- Test Instrumentation
- Microwave Radio & VSAT
- Military & Space
- Telecom Infrastructure
- Fiber Optics

Electrical Specifications

TA = +25°C, Vd = +10V

Parameters	Min.	Typ.	Max.	Units
Frequency	6-18			GHz
Small Signal Gain	15	16.5	18	dB
Gain Flatness		±1.5		dB
Output 1dB Compression (P1dB)	25	27.5	29	dBm
Saturated Output Power (Psat)	26.5	28.5	30	dBm
Input Return Loss	10	15		dB
Output Return Loss	8	17		dB
Quiescent Current		340		mA

Gain vs. Frequency

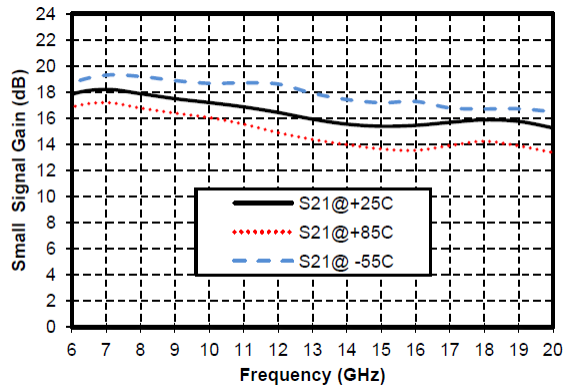

Reverse Isolation vs. Frequency

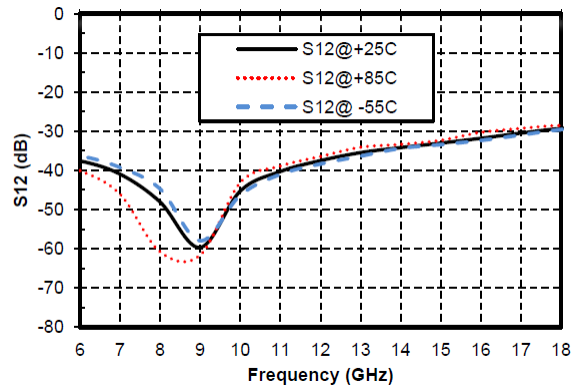

Input Return Loss vs. Frequency

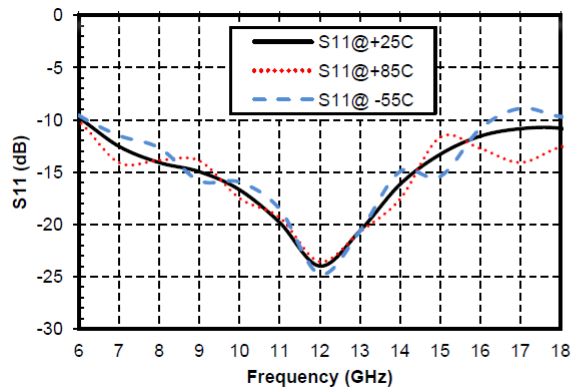

Output Return Loss vs. Frequency

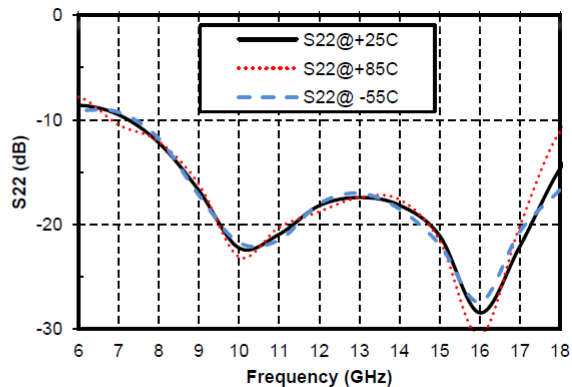

P-1dB vs. Frequency

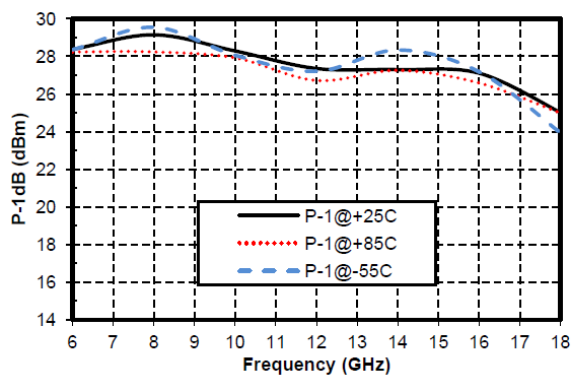

Psat vs. Frequency

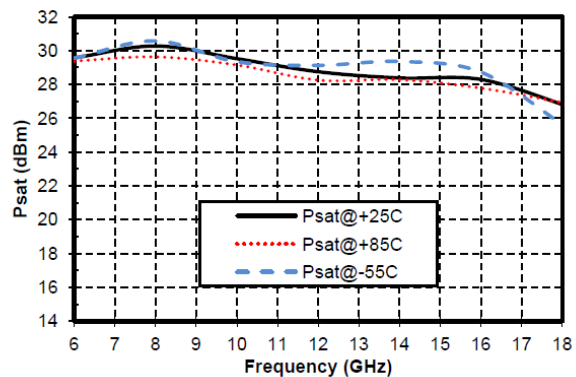



Outline Drawing: All Dimensions in um

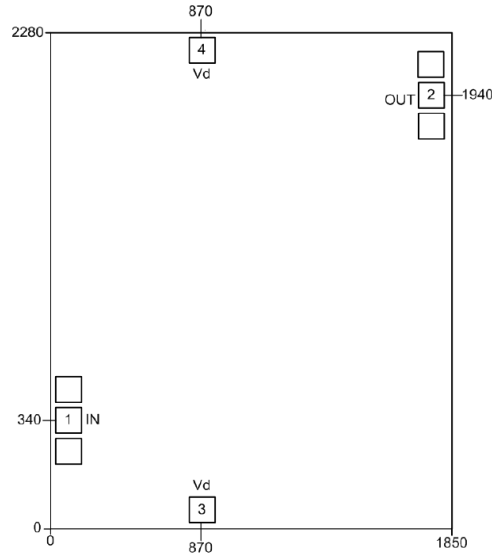

Pad Description

PAD	Function	Description
1	RF IN	RF signal input terminal, no blocking capacitor required
2	RF OUT	RF signal output terminal, no blocking capacitor required
3,4*	Vd	Amplifier drain bias, connected to external 100pF, 1000pF, and 100nF bypass capacitor.
Die Bottom	GND	Die bottom must be connected to RF/DC ground

*Port 3 and 4 need to power up at the same time.



Assembly Drawing

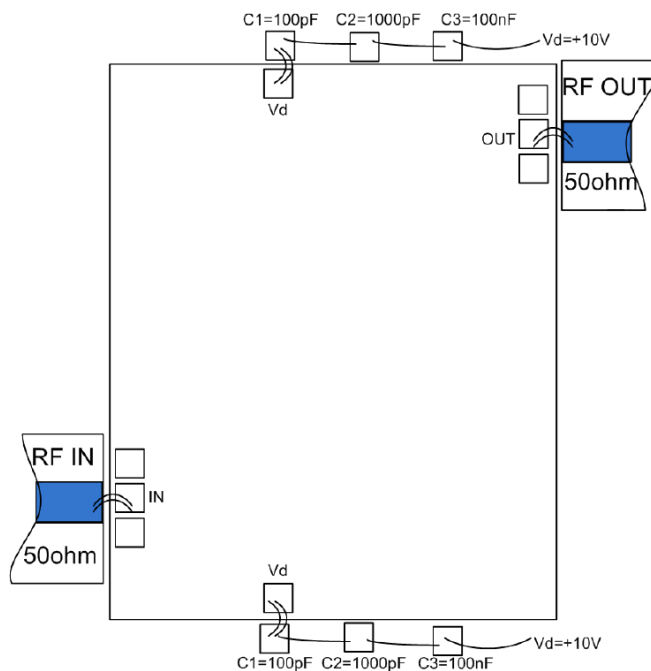

Notes:

1. Die thickness: 100um
2. Typical bond pad is 100*100 μm^2
3. Bond pad metalization: Gold
4. Backside metalization: Gold
5. Backside of the die (GND)
6. No connection required for unlabeled bond pads

Maximum Ratings:

1. Maximum drain voltage: +12V
2. Maximum input power: +20dBm
3. Operating temperature: -55°C to +85°C
4. Storage temperature: -65°C to +150°C