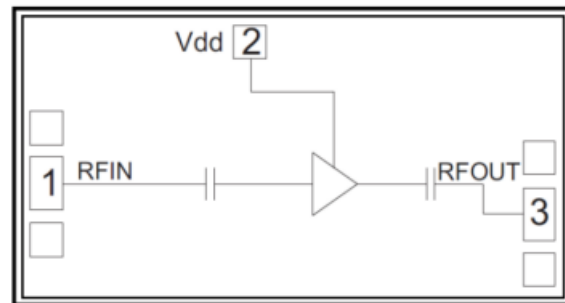

Features

- Single Biasing Voltage (Self Biased)
- Frequency: 6-18GHz
- Small Signal Gain: 9.5dB
- Gain Flatness: ± 0.25 dB
- Noise Figure: 3.5dB, typ.
- P1dB: 19.5dBm
- Psat: 20.5dBm
- Power Supply: +5V@75mA
- Input/Output: 50 Ω
- Die Size: 1.65 x 1.05 x 0.1 mm

Typical Applications

- Test Instrumentation
- Microwave Radio & VSAT
- Military & Space
- Telecom Infrastructure
- Fiber Optics

Functional Block Diagram

Electrical Specifications

TA = +25°C, Vd = +5V

Parameters	Min.	Typ.	Max.	Units
Frequency		6-18		GHz
Small Signal Gain		9.5		dB
Gain Flatness		± 0.25		dB
Noise Figure	3.2	3.5	3.7	dB
P1dB	19	19.5		dBm
Psat	20	20.5		dBm
Input Return Loss	13	18		dB
Output Return Loss	17	18		dB
Quiescent Current		75		mA

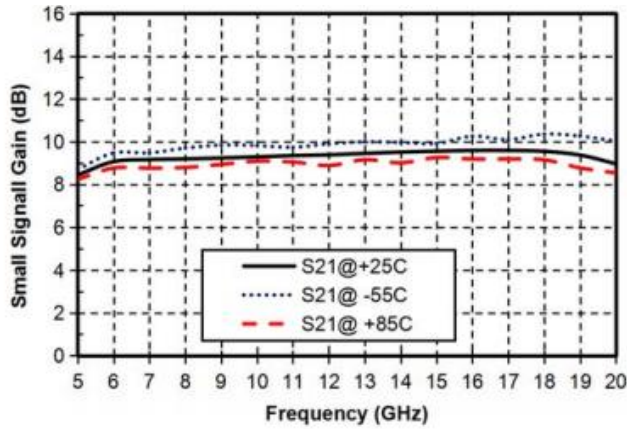
Gain vs. Frequency



Reverse Isolation vs. Frequency

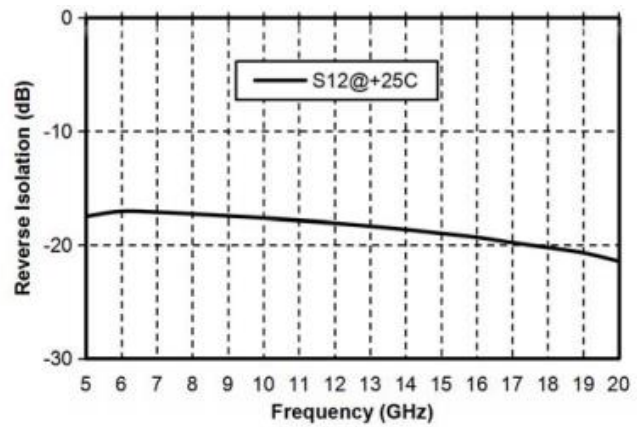

Input Return Loss vs. Frequency

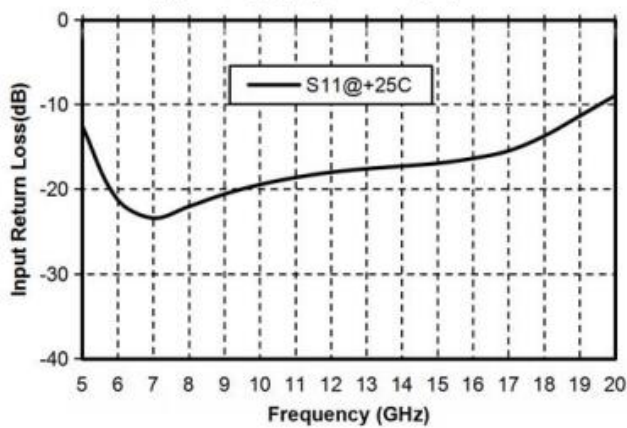

Output Return Loss vs. Frequency

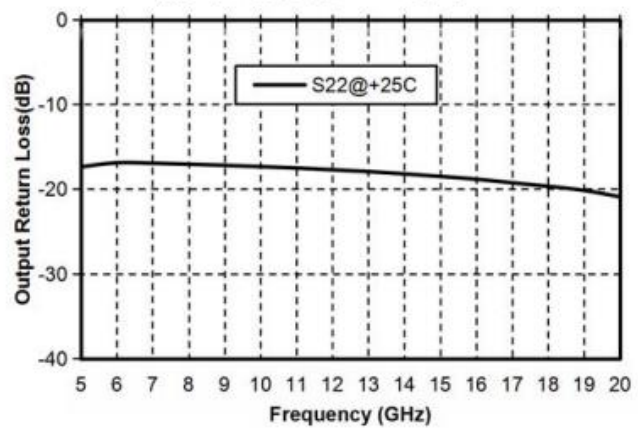

P-1dB vs. Frequency

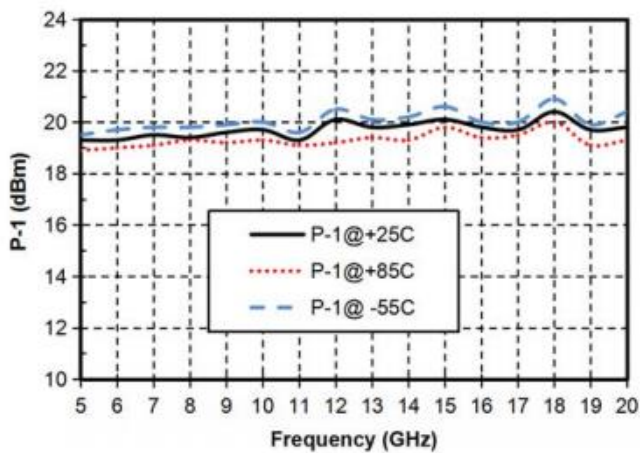

NF vs. Frequency

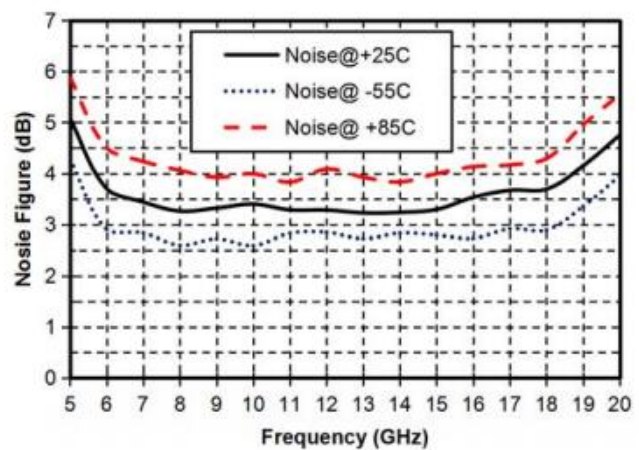



Outline Drawing:
All Dimensions in μm

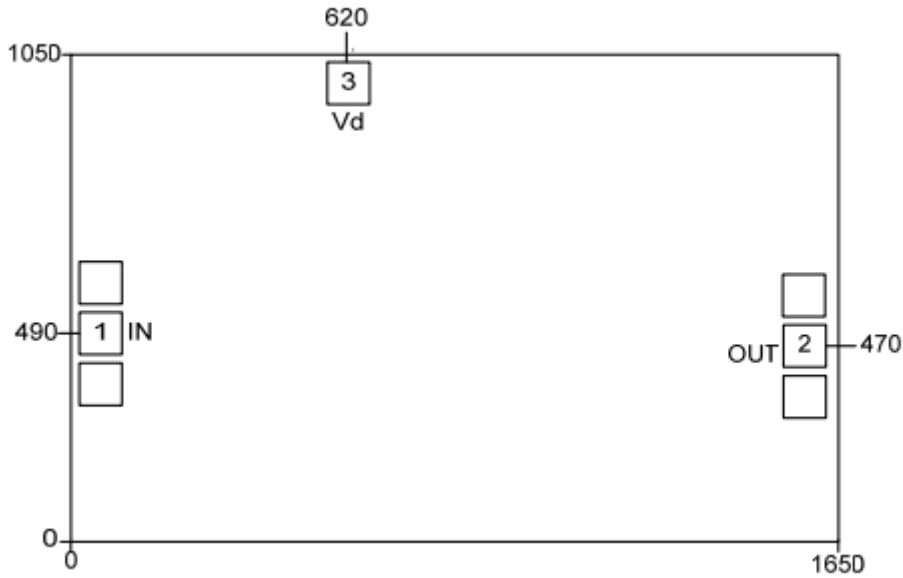

Pad Description

PAD	Function	Description	Equivalent Circuit
1	RF IN	RF signal input terminal, no blocking capacitor required	
2	RF OUT	RF signal output terminal, no blocking capacitor required	
3	Vd	Amplifier drain bias, connected to external 100pF bypass capacitor	
Die Bottom	GND	Die bottom must be connected to RF/DC ground	



Assembly Drawing

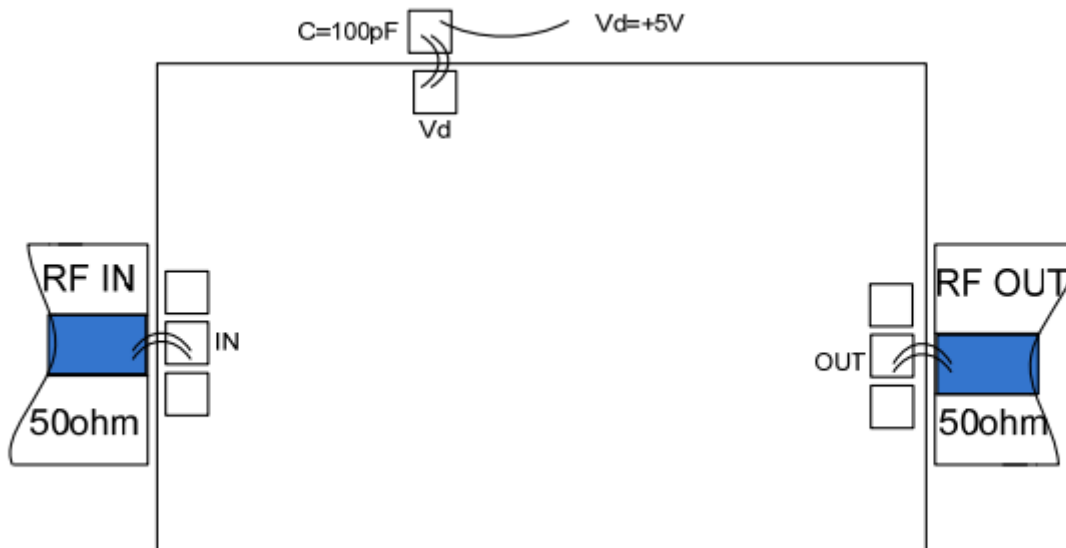

Notes:

1. Die thickness: 100um
2. Typical bond pad is 100*100 μm^2
3. Bond pad metalization: Gold
4. Backside metalization: Gold
5. Backside of the die (GND)
6. No connection required for unlabeled bond pads

Maximum Ratings:

1. Maximum drain voltage: +7V
2. Maximum input power: +20dBm
3. Operating temperature: -55°C to +85°C
4. Storage temperature: -65°C to +150°C