

### Features

- Ultra broadband single channel attenuator
- Frequency: DC-25GHz
- Attenuation 0, 1, 2...10,15, 20, 30dB value
- Power Handling: 27dBm
- Return Loss: 10dB
- Input/Output: 50Ω
- Package Size : Ceramic 3 x 3 x 0.7mm

### Functional Block Diagram

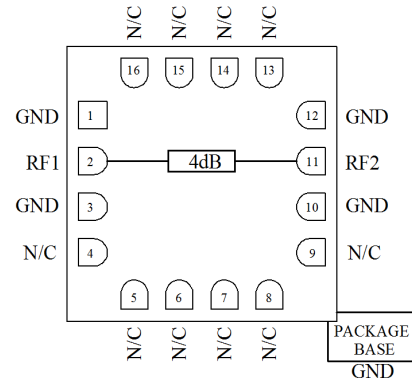

### Typical Applications

- Test Instrumentation
- Microwave Radio & VSAT
- Military & Space
- Telecom Infrastructure
- Fiber Optics

### Electrical Specifications

TA = +25°C

Part Number	Type	Frequency (GHz)	Attenuation (dB)	Power Handling (dBm)	Attenuation Flatness (dB)	Return Loss (dB)
MFA1001Q3A	Fixed Attenuator	DC-25	0	27	±0.3	15
MFA1002Q3A	Fixed Attenuator	DC-25	1	27	±0.5	10
MFA1003Q3A	Fixed Attenuator	DC-25	2	27	±0.3	10
MFA1004Q3A	Fixed Attenuator	DC-25	3	27	±0.3	10
MFA1005Q3A	Fixed Attenuator	DC-25	4	27	±0.3	10
MFA1006Q3A	Fixed Attenuator	DC-25	5	27	±0.3	15
MFA1007Q3A	Fixed Attenuator	DC-25	6	27	±0.3	15
MFA1008Q3A	Fixed Attenuator	DC-25	7	27	±0.5	15
MFA1009Q3A	Fixed Attenuator	DC-25	8	27	±0.5	15
MFA1010Q3A	Fixed Attenuator	DC-25	9	27	±0.5	15
MFA1011Q3A	Fixed Attenuator	DC-25	10	27	±1.0	18
MFA1012Q3A	Fixed Attenuator	DC-25	15	27	±1.0	18
MFA1013Q3A	Fixed Attenuator	DC-25	20	27	±0.4	12
MFA1014Q3A	Fixed Attenuator	DC-25	30	27	±1.5	10



### Attenuation vs. Frequency

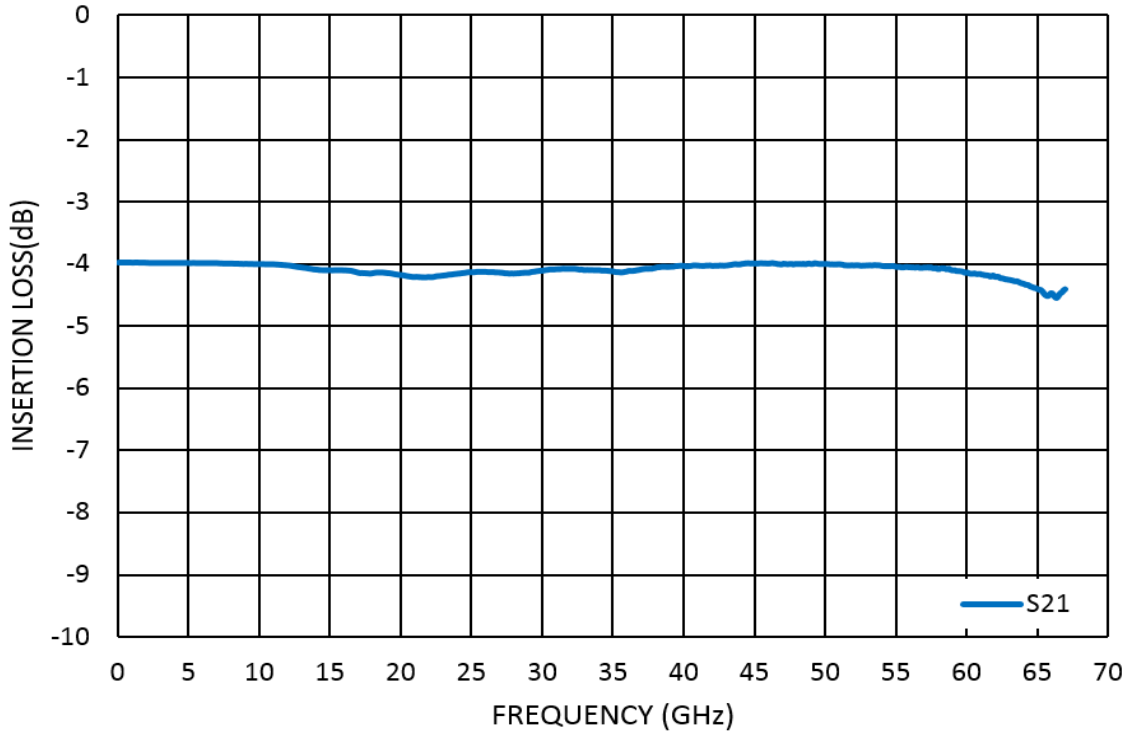

### Return Loss vs. Frequency

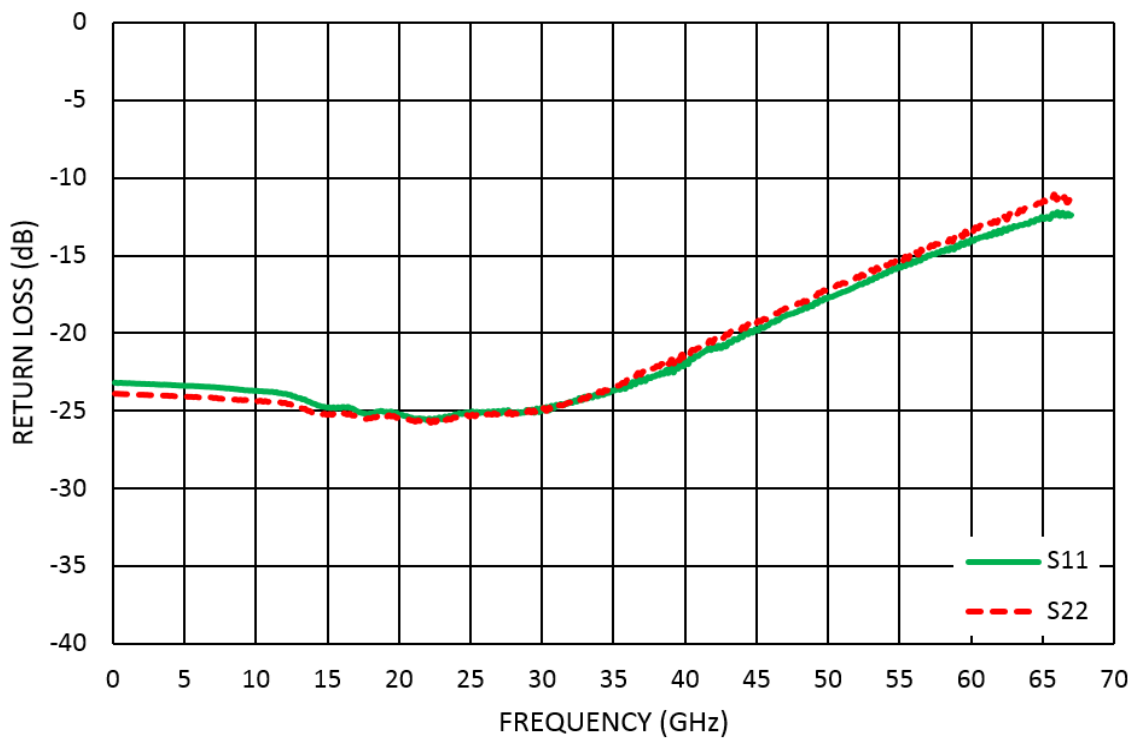



**Outline Drawing:**  
All Dimensions in mm[inches]

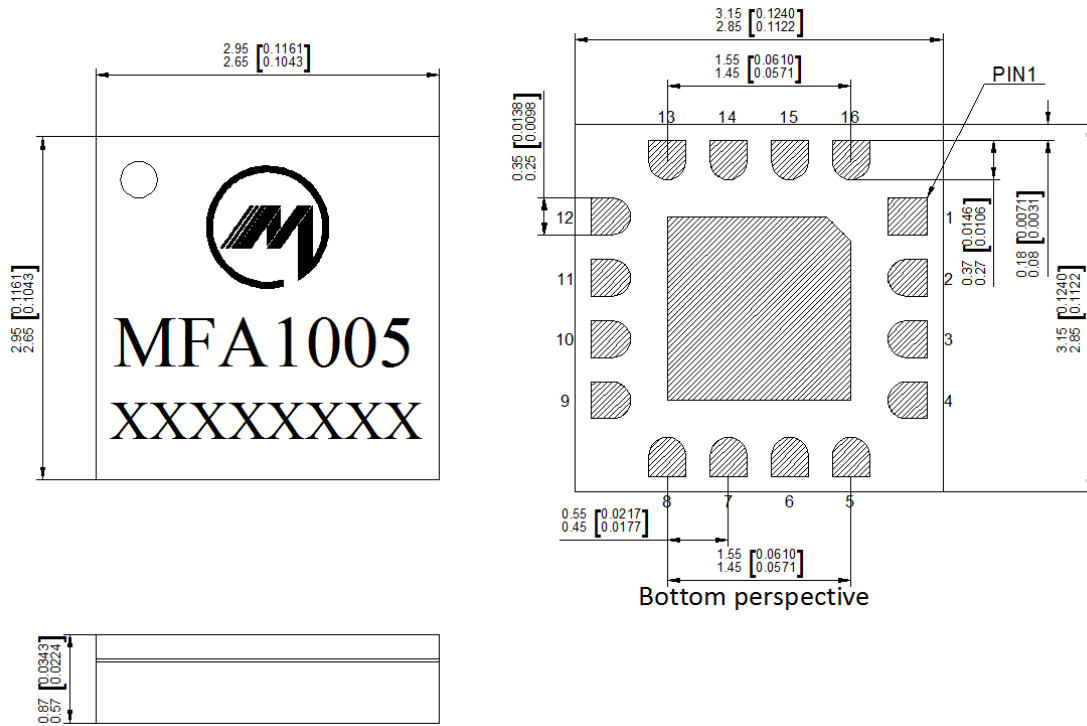

**Notes:**

1. Package body material : Alumina.
2. Lead and ground paddle plating: Gold flash over nickel.
3. Dimensions are in millimeters(inches).
4. Lead spacing tolerance is non-cumulative.

**Maximum Ratings:**

1. Maximum input power: +27dBm
2. Operating temperature: -55°C to +85°C
3. Storage temperature: -65°C to +150°C

**Pin Descriptions**

No	Function	Description
4,5,6,7,8,9,13,14,15,16	NC	No connection. These pins may be connected to RF ground. Performance will not be affected.
2	RF1	RF Signal Input. This pad is ac-coupled and matched to 50 Ω.
11	RF2	RF Signal Output. This pad is ac-coupled and matched to 50 Ω.
1,3,10,12	GND	These pins & exposed ground paddle must be connected to RF/DC ground
Die Bottom	GND	Package bottom must be connected to RF/DC ground



# MILLER MMIC

V1.0.0

## MFA1005Q3A

Fixed Attenuator Single Channel  
Ceramic QFN 3x3mm DC-25GHz

**Miller MMIC Inc. All rights reserved**

Miller MMIC, Inc. holds exclusive rights to the information presented in its Data Sheet and any accompanying materials. As a premier supplier of cutting-edge RF solutions, Miller MMIC has made this information easily accessible to its clients.

Although Miller MMIC believes the information provided in its Data Sheet to be trustworthy, the company does not offer any guarantees as to its accuracy. Therefore, Miller MMIC bears no responsibility for the use of this information. It is worth mentioning that the information within the Data Sheet may be altered without prior notification.

Customers are encouraged to obtain and verify the most recent and pertinent information before placing any orders for Miller MMIC products. The information in the Data Sheet does not confer, either explicitly or implicitly, any rights or licenses with regards to patents or other forms of intellectual property to any third party.

The information provided in the Data Sheet, or its utilization, does not bestow any patent rights, licenses, or other forms of intellectual property rights to any individual or entity, whether in regards to the information itself or anything described by such information. Furthermore, Miller MMIC products are not intended for use as critical components in applications where failure could result in severe injury or death, such as medical or life-saving equipment, or life-sustaining applications, or in any situation where failure could cause serious personal injury or death.

MFA1005Q3A

Ceramic QFN 3x3mm Fixed Attenuator DC-25GHz