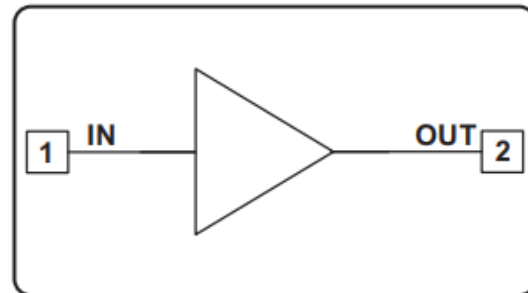

Features

- Operating Frequency: DC-4GHz
- Gain 16dB
- Noise Figure 3.5dB
- DC Power Supply: 5V/40 mA
- Reverse Isolation : 20dB
- P1dB: +15dBm
- Die Size: 0.5 x 0.5 x 0.1 mm

Functional Block Diagram

Typical Applications

- Test Instrumentation
- Microwave Radio & VSAT
- Military & Space
- Telecom Infrastructure
- Fiber Optics

Electrical Specifications

TA = +25°C, 5V /40mA

Parameters	Min.	Typ.	Max.	Units
Frequency	DC - 4			GHz
Gain		16		dB
Input Return Loss		20		dB
Output Return Loss		20		dB
Reverse Isolation		20		dB
Output 1dB Compression (P1dB)		15		dBm
Noise Figure		3.5		dB
Input Third-order Intercept Point (IP3)		20		dBm
Current	25	40	55	mA



Gain vs. Temperature

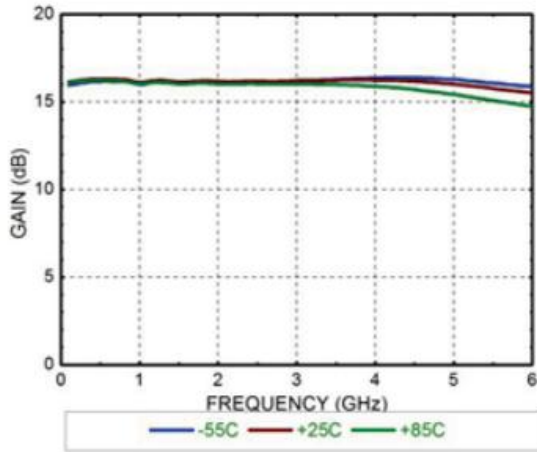

Return Loss

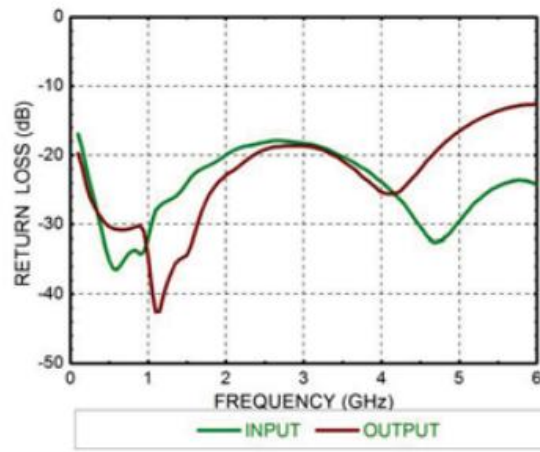

Noise Figure

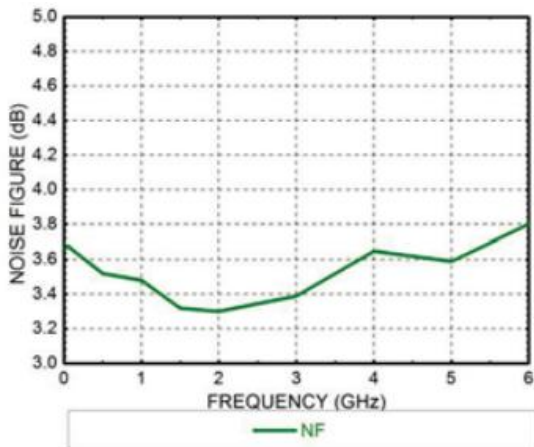

Output Power P1dB

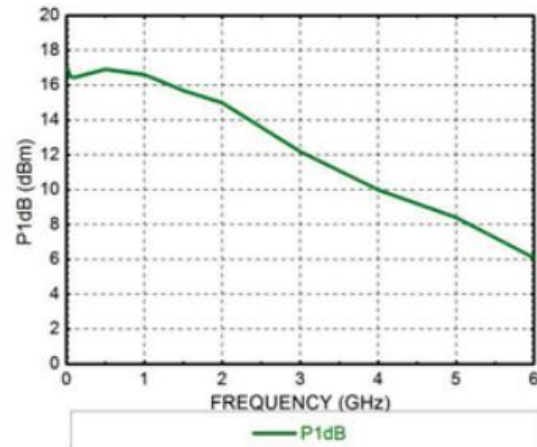



Outline Drawing:

All Dimensions in mm

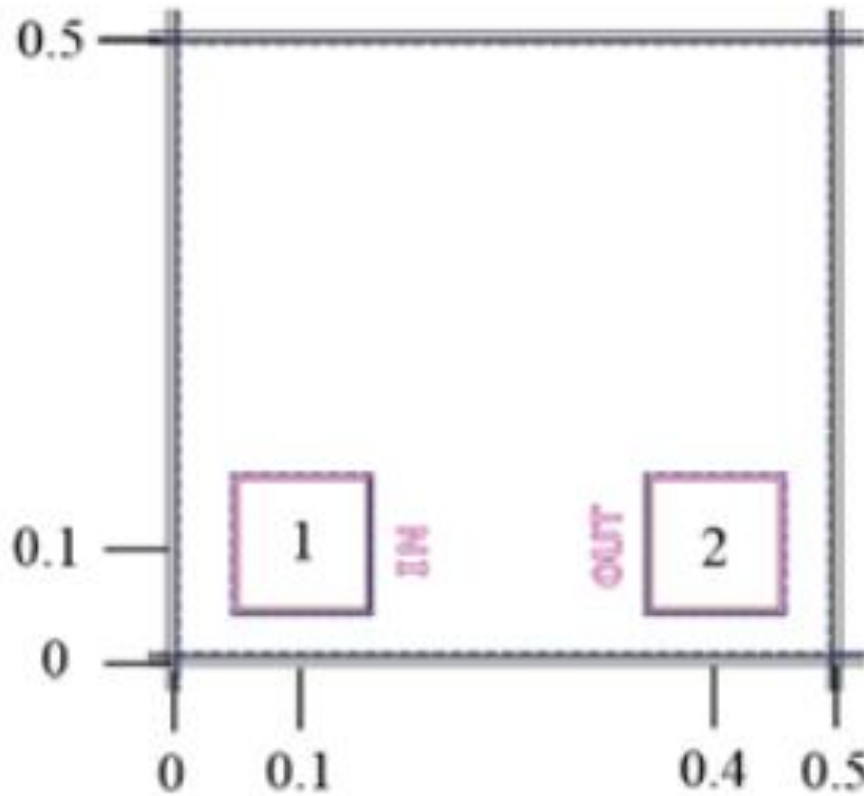

Pad Description

PAD	Function	Description
1	IN	Input AC coupling 50Ω Impedance
2	OUT	Output AC coupling 50Ω Impedance
Die Bottom	GND	Die bottom must be connected to RF/DC ground



Recommended bias circuit

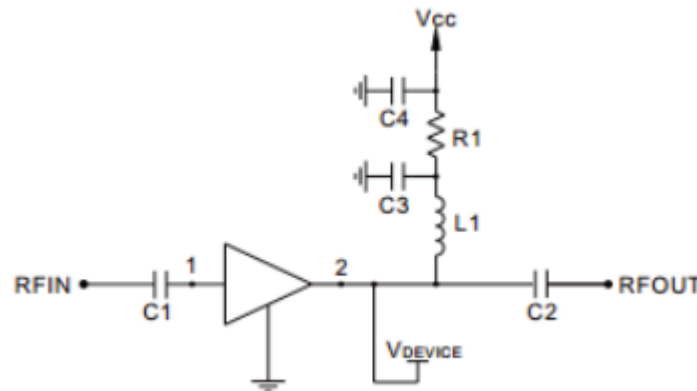

Frequency	100MHz	1GHz	2GHz	4GHz
L1(nH)	270	82	47	8.2
C1/C2(pF)	10000	1000	100	100
C3/C4(pF)	0.001/0.01			
Voltage	5	8	10	12
R1(Ω)	12	85	135	180

Notes:

1. Die thickness: 100um
2. Typical bond pad is 100*100 μm²
3. Bond pad metalization: Gold
4. Backside metalization: Gold
5. Backside of the die (GND)
6. No connection required for unlabeled bond pads

Maximum Ratings:

1. Power supply voltage: +6V
2. RF input power: +10dBm
3. Storage temperature: -65°C to +175°C
4. Operating temperature: -55°C to +85°C