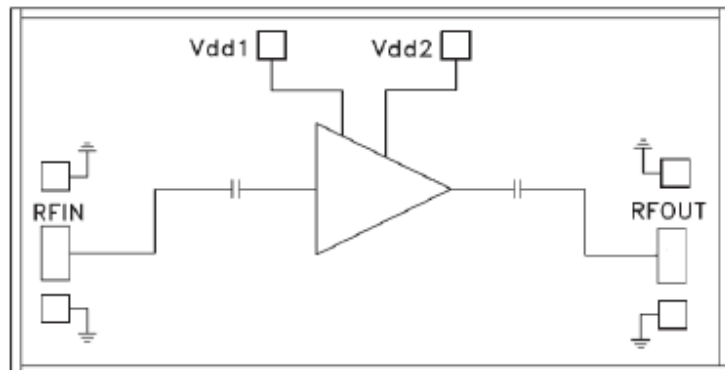

**Features**

- Frequency: 12-19GHz
- Small Signal Gain: 19dB
- Noise Figure: 1.35dB typ.
- Noise Figure: 1.4dB max.
- P1dB: 7dBm
- Power Supply: +3.3V/25mA
- Input/Output: 50Ω
- Die Size: 1.85 x 0.9 x 0.1 mm

**Typical Applications**

- Test Instrumentation
- Microwave Radio & VSAT
- Military & Space
- Telecom Infrastructure
- Fiber Optics

**Functional Block Diagram**

**Electrical Specifications**
**TA = +25°C, Vd = +3.3V**

Parameters	Min.	Typ.	Max.	Units
<b>Frequency</b>	<b>12-19</b>			<b>GHz</b>
<b>Small Signal Gain</b>	<b>18.5</b>	<b>19</b>	<b>19.5</b>	<b>dB</b>
<b>Gain Flatness</b>		<b>±0.5</b>		<b>dB</b>
<b>Noise Figure</b>	-	<b>1.35</b>	<b>1.4</b>	<b>dB</b>
<b>Output 1dB Compression (P1dB)</b>	<b>6.5</b>	<b>7</b>	<b>7.5</b>	<b>dBm</b>
<b>Input Return Loss</b>	<b>11</b>	<b>12</b>	-	<b>dB</b>
<b>Output Return Loss</b>	<b>12</b>	<b>18</b>	-	<b>dB</b>
<b>Static Current</b>		<b>25</b>		<b>mA</b>

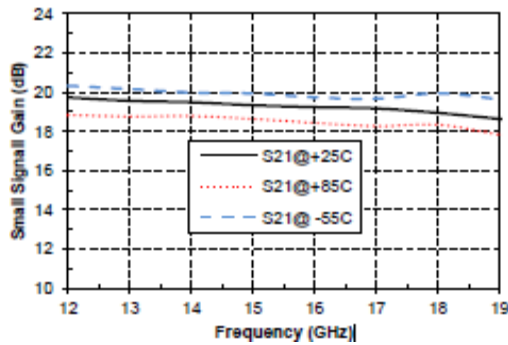
### Gain vs. Frequency

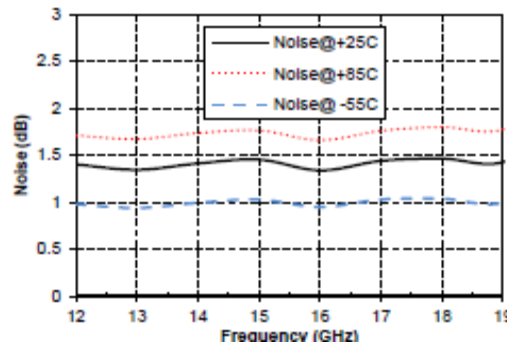

### Noise Figure vs. Frequency



### Input Return Loss vs. Frequency

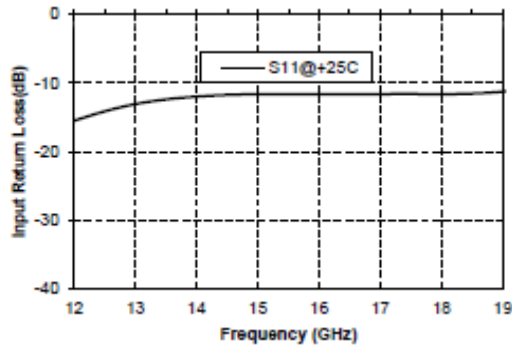

### Output Return Loss vs. Frequency

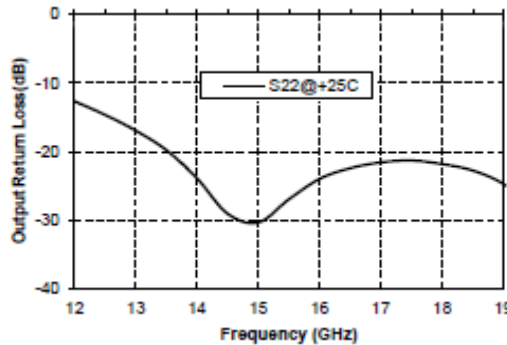

### Reverse Isolation vs. Frequency

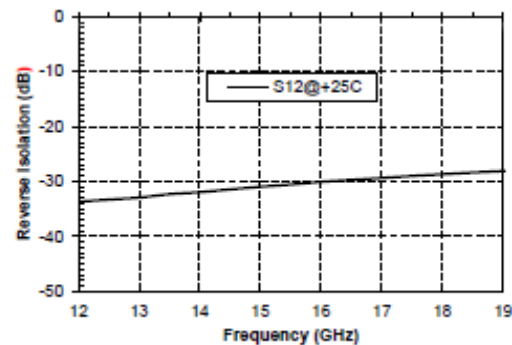

### P1dB vs. Frequency

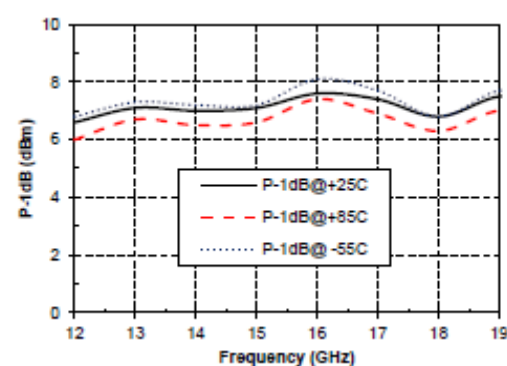



**Outline Drawing:**  
All Dimensions in  $\mu\text{m}$

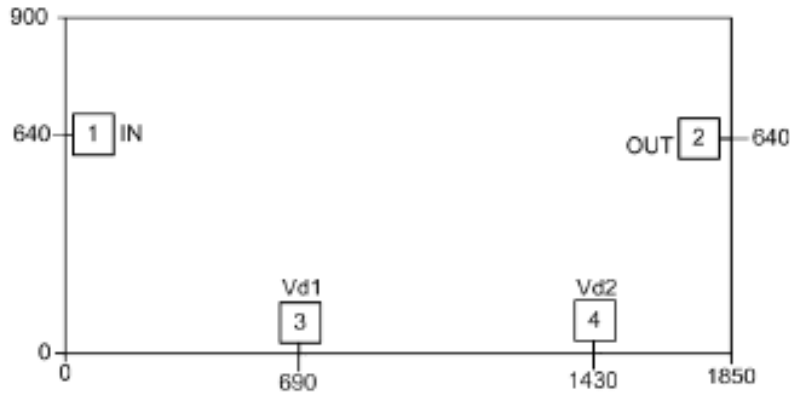

**Pad Description**

Pad	Function	Description	Equivalent Circuit
1	RF IN	RF signal input terminal, no blocking capacitor required.	
2	RF OUT	RF signal output terminal, no blocking capacitor required.	
3	VDD	Amplifier drain bias; external 100pF bypass capacitor required.	
Die bottom	GND	Die bottom must be connected to RF/DC ground.	



### Assembly Drawing

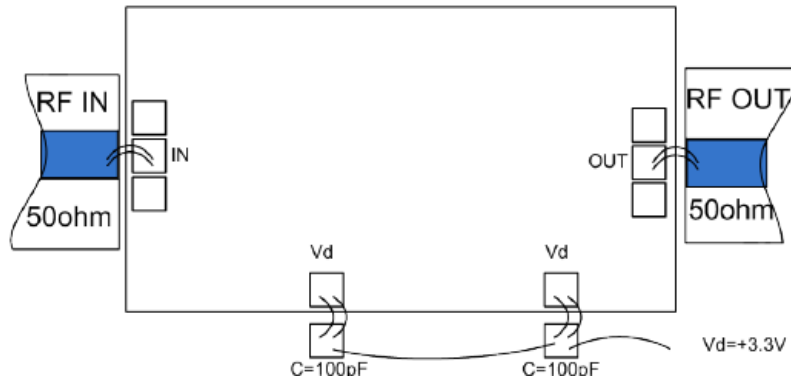

#### Notes:

1. Die thickness: 100um
2. Typical bond pad is 100\*100  $\mu\text{m}^2$
3. Bond pad metalization: Gold
4. Backside metalization: Gold
5. Backside of the die (GND)
6. No connection required for unlabeled bond pads

#### Maximum Ratings:

1. Maximum drain voltage: +5V
2. Maximum input power: +20dBm
3. Operating temperature: -55°C to +85°C
4. Storage temperature: -65°C to +150°C