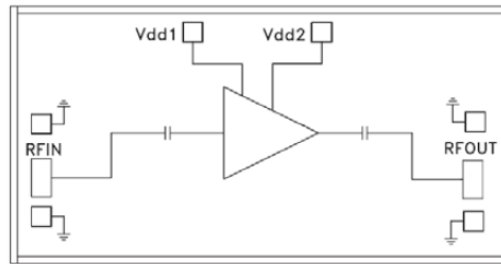

Features

- Frequency: 18-40GHz
- Small Signal Gain: 11dB(Positive Slope)
- Noise Figure: 2.9 dB typ./3.3dB max.
- P1dB: 15dBm
- Power Supply: +5V/52mA
- Input/Output: 50Ω
- Die Size: 1.85 x 1.6 x 0.09 mm

Functional Block Diagram

Typical Applications

- Test Instrumentation
- Microwave Radio & VSAT
- Military & Space
- Telecom Infrastructure
- Fiber Optics

Electrical Specifications

TA = +25°C, Vd = +5V

Parameters	Min.	Typ.	Max.	Units
Frequency	18-40			GHz
Small Signal Gain	10	11	11.5	dB
Gain Flatness		±0.75		dB
Noise Figure	-	2.9	3.3	dB
Output 1dB Compression (P1dB)	11	15	16	dBm
Saturated Output Power (Psat)	13.5	16.5	18	dBm
Input Return Loss	19	25	-	dB
Output Return Loss	19	23	-	dB
Static current		52		mA



Gain vs. Frequency

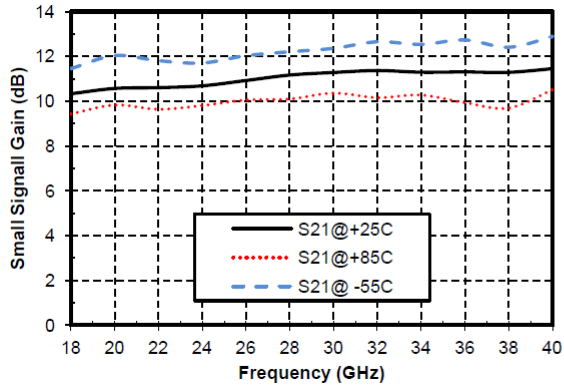

Noise Figure vs. Frequency

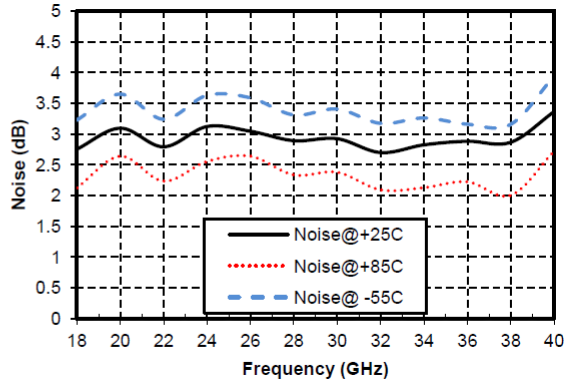

Input Return Loss vs. Frequency

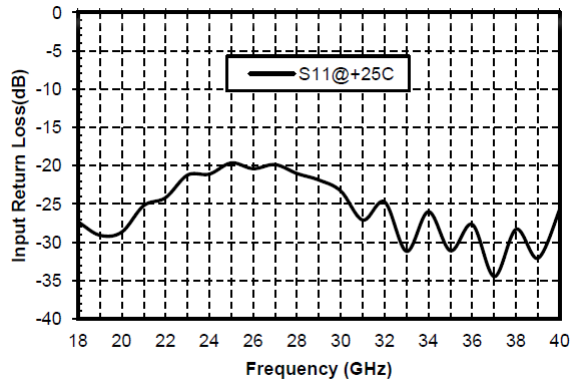

Output Return Loss vs. Frequency

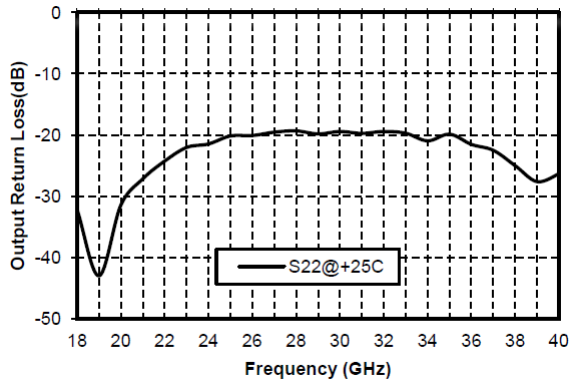

Reverse Isolation vs. Frequency

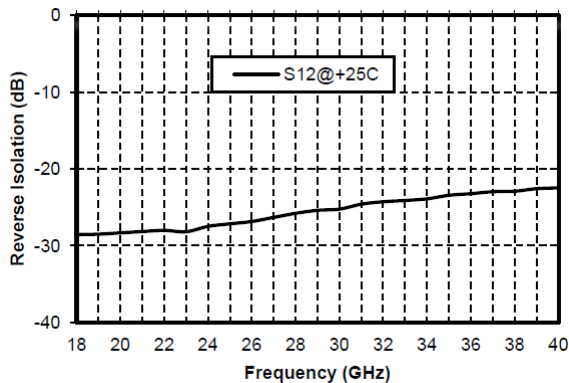

P1dB/Psat vs. Frequency

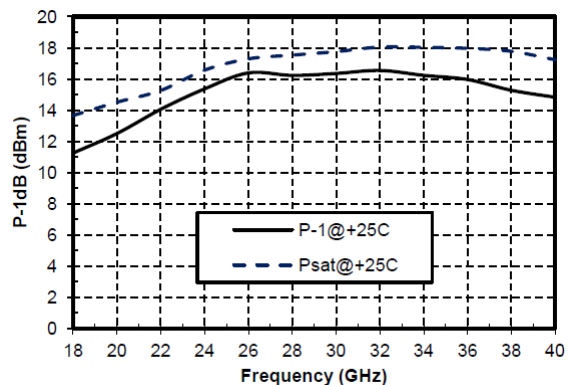



Outline Drawing:
All Dimensions in μm

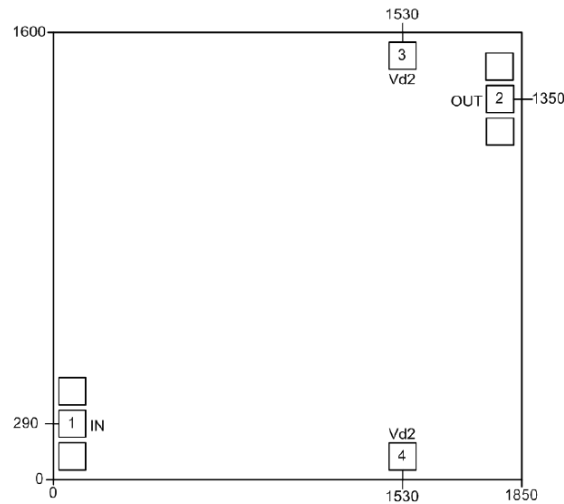

Pad Description

Pad	Function	Description	Equivalent Circuit
1	RF IN	RF signal input terminal, no blocking capacitor required.	
2	RF OUT	RF signal output terminal, no blocking capacitor required.	
3	Vd	Amplifier drain bias; external 100pF bypass capacitor required. Single-side power supply, only one side Vd need to be bonded.	
Die bottom	GND	Die bottom must be connected to RF/DC ground.	



Assembly Drawing

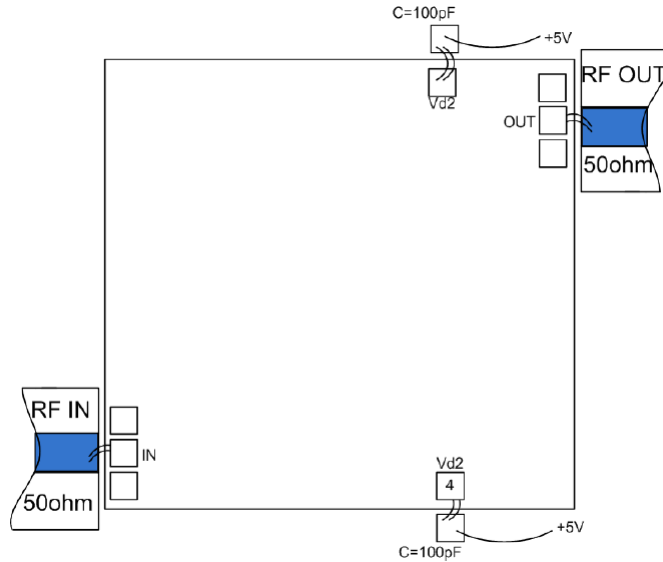

*single-side power supply, only one side Vd need to be bonded.

Notes:

1. Die thickness: 100um
2. Typical bond pad is 100*100 μm^2
3. Bond pad metalization: Gold
4. Backside metalization: Gold
5. Backside of the die (GND)
6. No connection required for unlabeled bond pads

Maximum Ratings:

1. Maximum drain voltage: +7V
2. Maximum input power: +20dBm
3. Operating temperature: -55°C to +85°C
4. Storage temperature: -65°C to +150°C