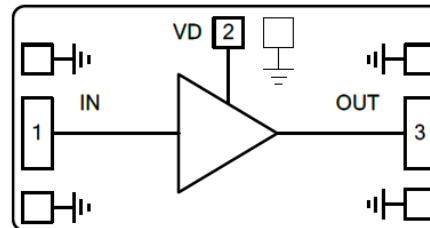

**Features**

- Single Biasing Voltage (Self Biased)
- Operating Frequency: 0.1-20GHz
- Noise Figure: 1.6dB
- Gain: 23dB
- P1dB: +11dBm
- Self Biasing +5V @ 58 mA
- Input/Output: 50Ω matched
- Die Size: 1.5 x 0.8 x 0.1 mm

**Typical Applications**

- Test Instrumentation
- Microwave Radio & VSAT
- Military & Space
- Telecom Infrastructure
- Fiber Optics

**Functional Block Diagram**

**Electrical Specifications**
**TA = +25°C, Vdd = +5V, Idd = 58mA**

Parameters	Min.	Typ.	Max.	Units
<b>Frequency</b>	<b>0.1-20</b>			<b>GHz</b>
<b>Gain</b>		<b>23</b>		<b>dB</b>
<b>Gain Flatness</b>		<b>±0.3</b>		<b>dB</b>
<b>Input Return Loss</b>		<b>12</b>		<b>dB</b>
<b>Output Return Loss</b>		<b>12</b>		<b>dB</b>
<b>Output 1dB Compression (P1dB)</b>		<b>11</b>		<b>dBm</b>
<b>Saturated Output Power (Psat)</b>		<b>13</b>		<b>dBm</b>
<b>Output Third Order Intercept (IP3)</b>		<b>21</b>		<b>dBm</b>
<b>Noise Figure</b>		<b>1.6</b>		<b>dB</b>
<b>Operating Current</b>	<b>42</b>	<b>58</b>	<b>73</b>	<b>mA</b>

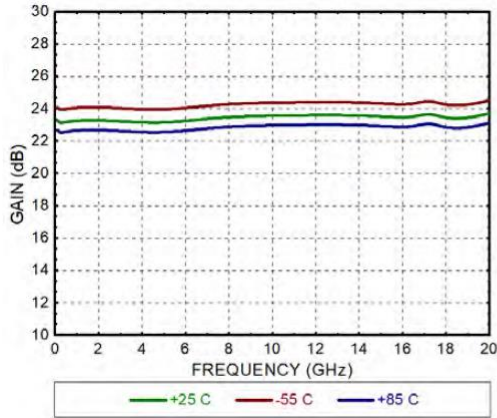

### Gain



### Return Loss

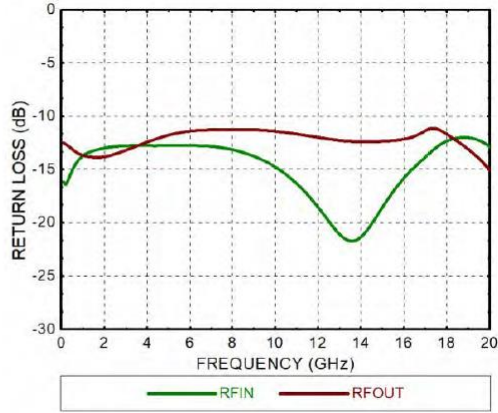

### Noise Figure

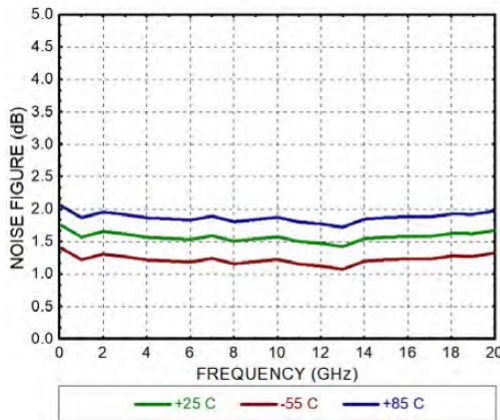

### Output Power $P_{1dB}$

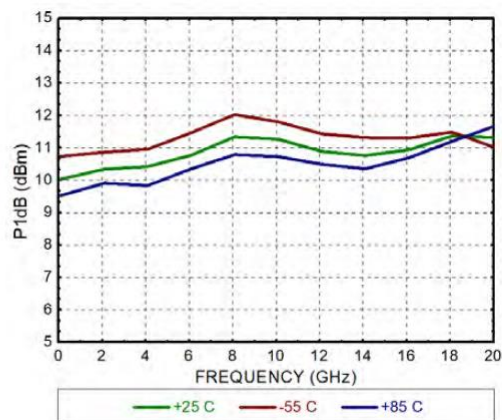



### Outline Drawing:

All Dimensions in mm

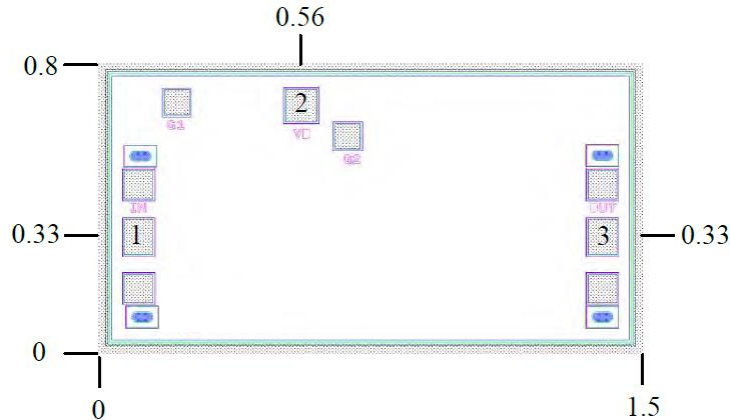

### Pad Description

PAD	Function	Description
1	IN	This pad is DC coupling, 50 ohm matched, external 200pF DC blocking capacitor required.
2	VD	This pad provides the power supply voltage of the amplifier and needs to be externally connected with the 1000pF bypass capacitor.
3	OUT	This pad is DC coupling, 50 ohm matched, external 200pF DC blocking capacitor required.
Die Bottom	GND	Die bottom must be connected to RF/DC ground.



### Assembly Drawing

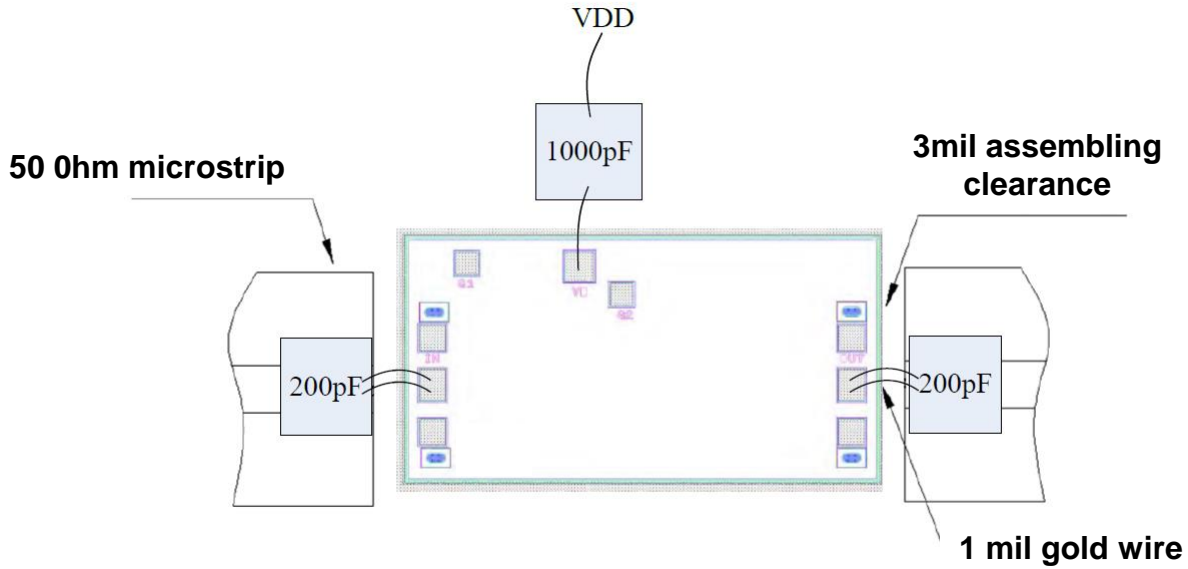

#### Notes:

1. Die thickness: 100um
2. Typical bond pad is 100\*80  $\mu\text{m}^2$
3. Bond pad metalization: Gold
4. Backside metalization: Gold
5. Backside of the die (GND)
6. No connection required for unlabeled bond pads

#### Maximum Ratings:

1. Power supply voltage: +6V
2. RF input power: +15dBm
3. Storage temperature: -65°C to +150°C
4. Operating temperature: -55°C to +85°C