

Features

- Single Biasing Voltage (Self Biased)
- Frequency: 10-20GHz
- Small Signal Gain: 26.5dB (positive slope)
- Noise Figure: 1.2dB
- P1dB: 1.5dBm
- Power Supply: +5V/10mA
- Input/Output: 50Ω
- Die Size: 1.85 x 1.25 x 0.09 mm

Typical Applications

- Test Instrumentation
- Microwave Radio & VSAT
- Military & Space
- Telecom Infrastructure
- Fiber Optics

Electrical Specifications

TA = +25°C, Vd = +5V

Parameters	Min.	Typ.	Max.	Units
Frequency	10-20			GHz
Small Signal Gain		26.5		dB
Gain Flatness		±1.0		dB
Noise Figure	-	1.3	-	dB
Output 1dB Compression (P1dB)		1.5		dBm
Input Return Loss		18		dB
Output Return Loss		20		dB
Quiescent Current		10		mA



Gain vs. Temperature

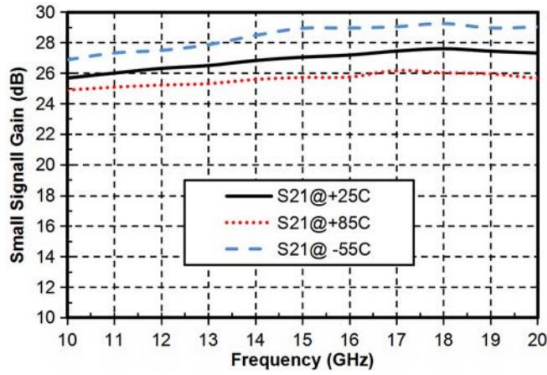

Noise Figure vs. Frequency

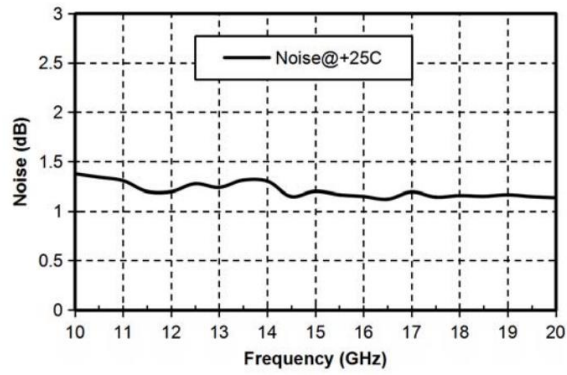

Input Return Loss vs. Frequency

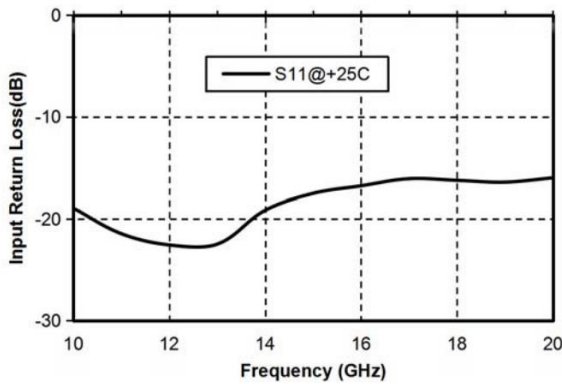

Output Return Loss vs. Frequency

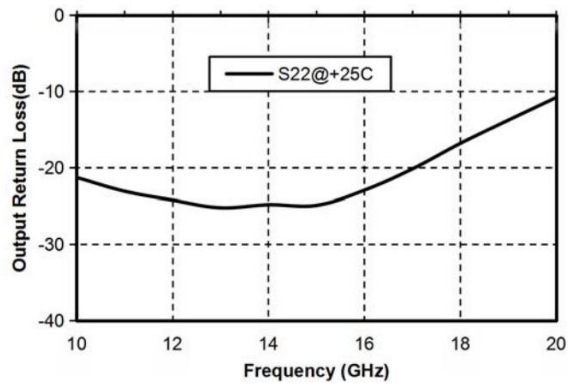

Reverse Isolation vs. Frequency

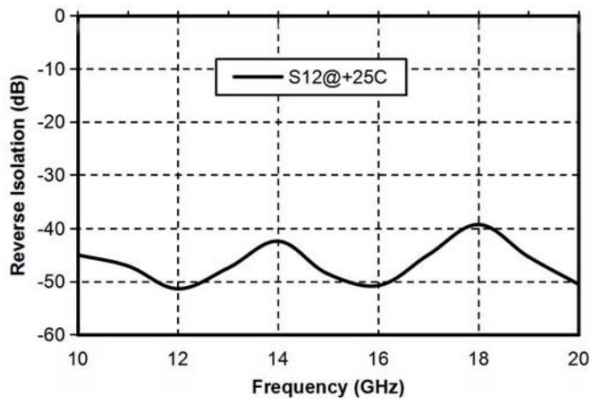

P1dB vs. Frequency

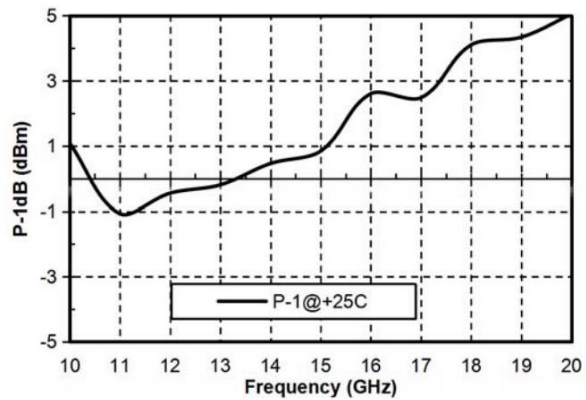



Outline Drawing: All Dimensions in μm

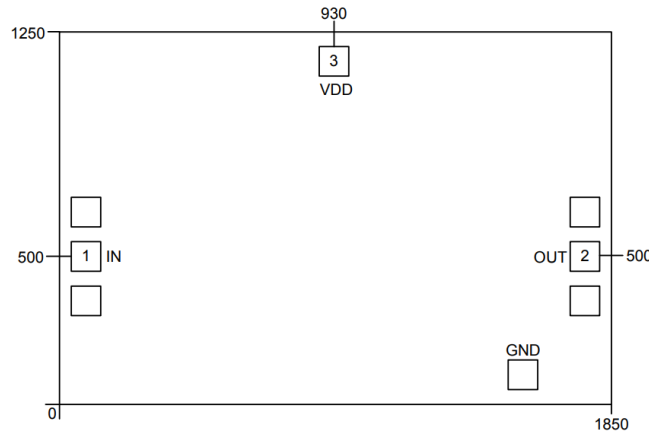

Pad Description

Pad	Function	Description
1	RF IN	RF signal input terminal; no blocking capacitor required.
2	RF OUT	RF signal output terminal; no blocking capacitor required.
3	Vd	Amplifier drain bias; external 100pF bypass capacitor required.
Die bottom	GND	Die bottom must be connected to RF/DC ground.



Assembly Drawing

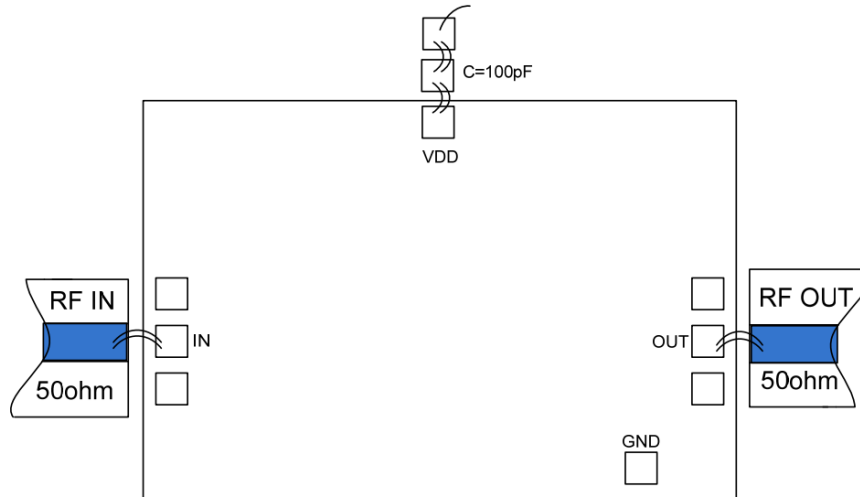

Notes:

1. Die thickness: 100um
2. Typical bond pad is 100*100 μm^2
3. Bond pad metalization: Gold
4. Backside metalization: Gold
5. Backside of the die (GND)
6. No connection required for unlabeled bond pads

Maximum Ratings:

1. Maximum drain voltage: +7V
2. Maximum input power: +20dBm
3. Operating temperature: -55°C to +85°C
4. Storage temperature: -65°C to +150°C