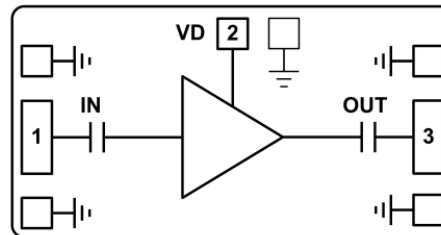

Features

- Single Biasing Voltage (Self Biased)
- Operating Frequency: 6-28GHz
- Noise Figure: 2dB
- Gain: 23.5dB
- P1dB: +17.5dBm
- Self Biasing +5V @ 77 mA
- Input/Output: 50Ω matched
- Die Size: 2 x 0.8 x 0.1 mm

Typical Applications

- Test Instrumentation
- Microwave Radio & VSAT
- Military & Space
- Telecom Infrastructure
- Fiber Optics

Functional Block Diagram

Electrical Specifications
TA = +25°C, Vdd = +5V, Idd = 77mA

Parameters	Min.	Typ.	Max.	Units
Frequency		6-28		GHz
Gain		23.5		dB
Gain Flatness		±1		dB
Input Return Loss		12		dB
Output Return Loss		12		dB
Output 1dB Compression (P1dB)		17.5		dBm
Saturated Output Power (Psat)		18.5		dBm
Output Third Order Intercept (IP3)		30		dBm
Noise Figure		2		dB
Operating Current	50	77	105	mA

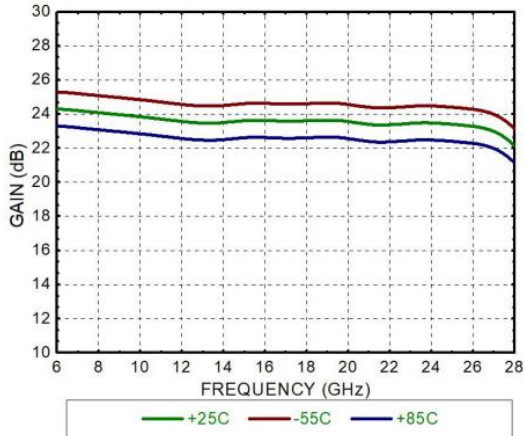

Gain



Return Loss & Reverse Isolation

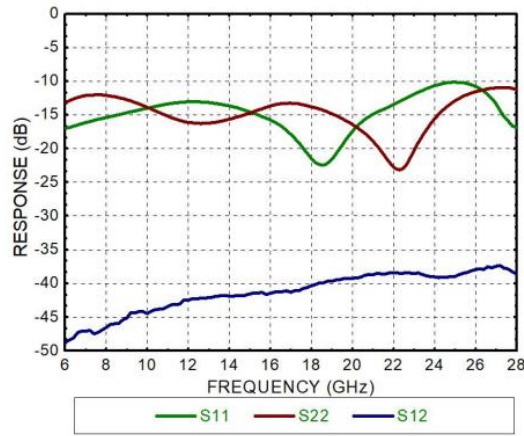

Noise Figure

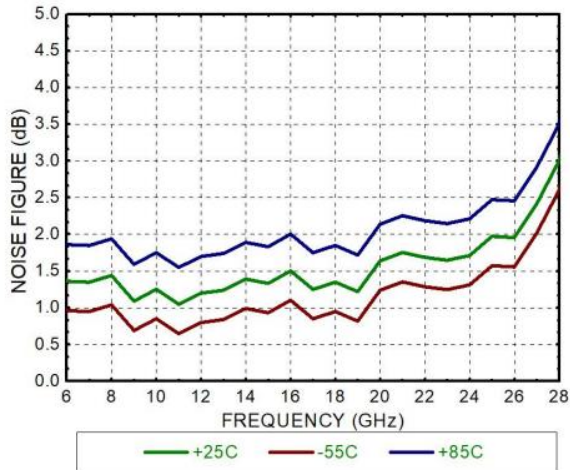

Output Power P₁

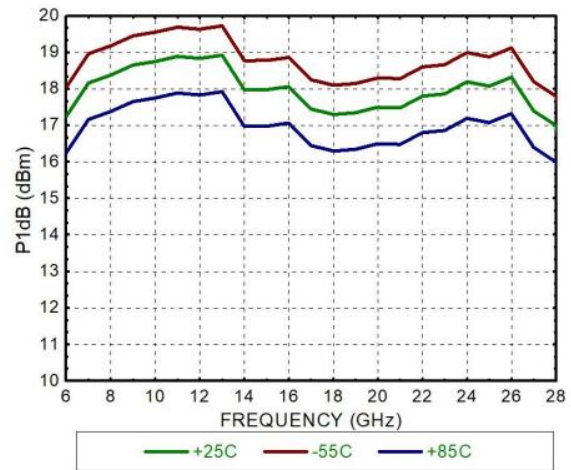

Psat

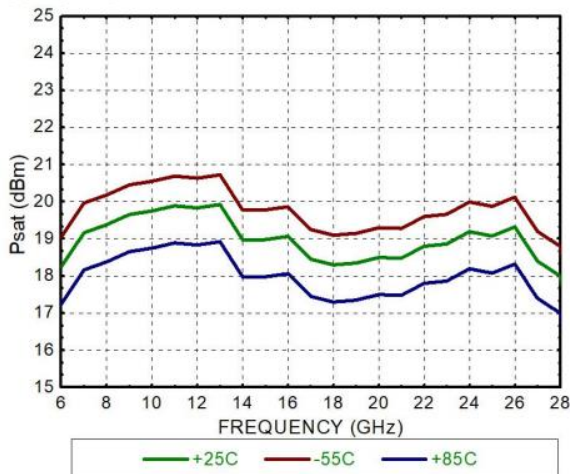

OIP3

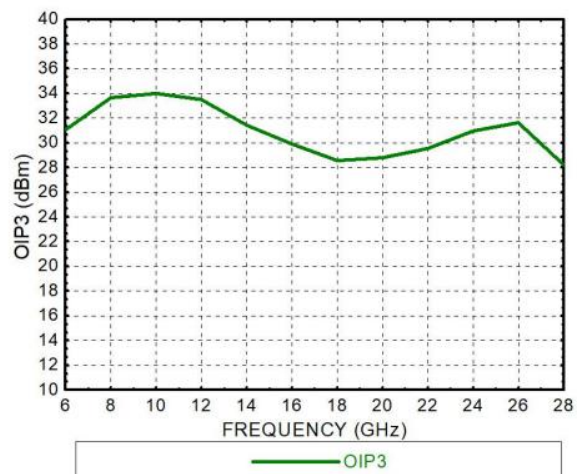



Outline Drawing:

All Dimensions in mm

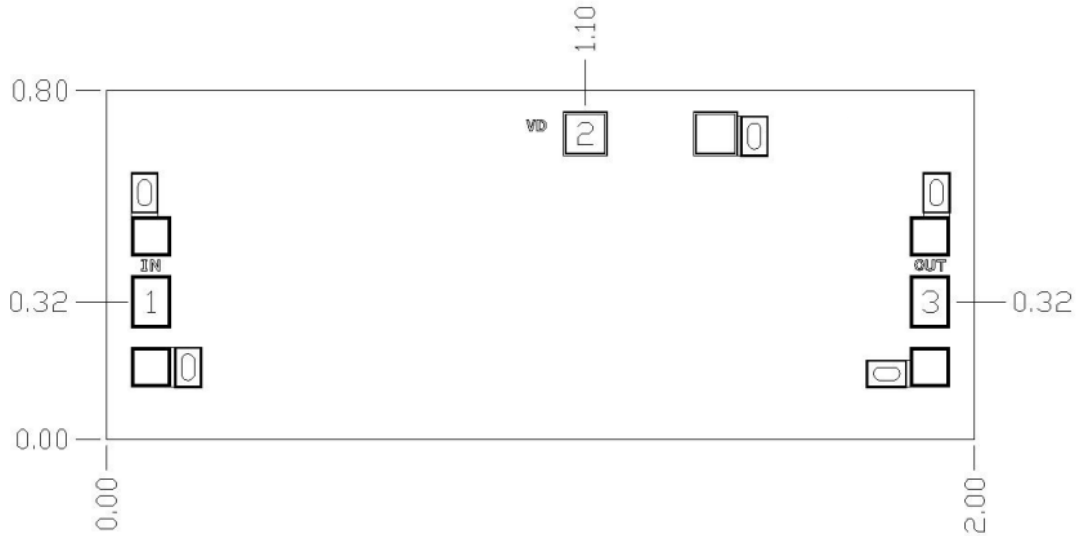

Pad Description

PAD	Function	Description
1	IN	This pad is AC coupling, 50 ohm matched
2	VD	This pad provides the power supply voltage of the amplifier and needs to be externally connected with the 100pF bypass capacitor.
3	OUT	This pad is AC coupling, 50 ohm matched
Die Bottom	GND	Die bottom must be connected to RF/DC ground.



Assembly Drawing

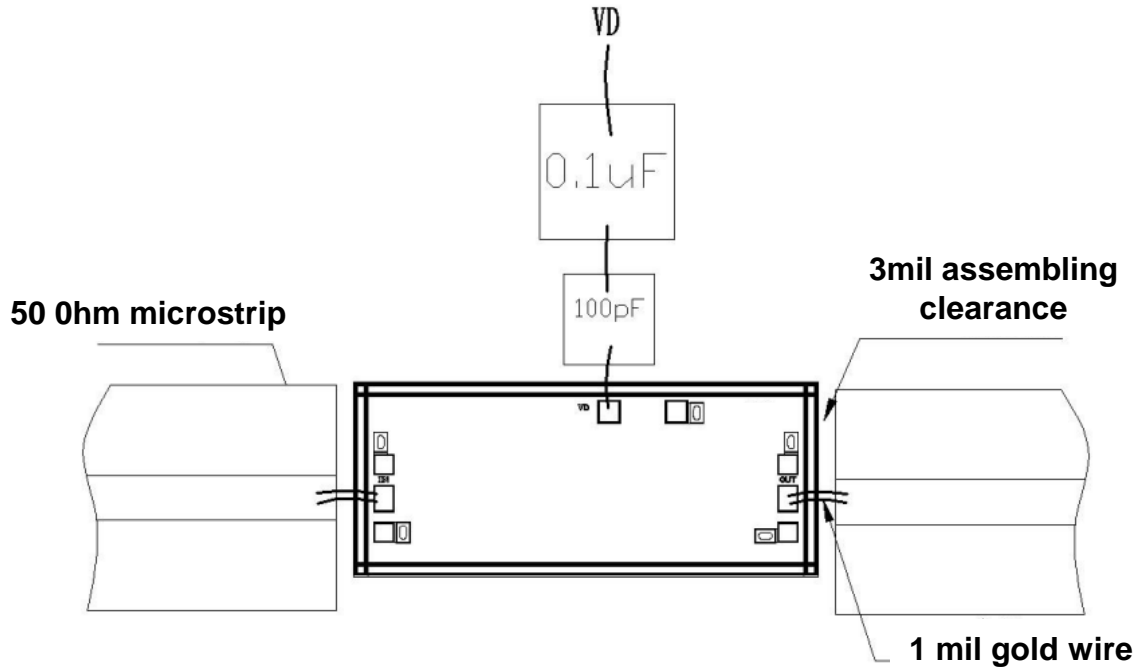

Notes:

1. Die thickness: 100um
2. Typical bond pad is 120*90 μm^2
3. Bond pad metalization: Gold
4. Backside metalization: Gold
5. Backside of the die (GND)
6. No connection required for unlabeled bond pads

Maximum Ratings:

1. Power supply voltage: +6V
2. RF input power: +18dBm
3. Storage temperature: -65°C to +150°C
4. Operating temperature: -55°C to +85°C