



Features

- Frequency: 8-12GHz
- Small Signal Gain: 16.5dB
- P-1dB: 31.5dBm
- Psat: 32dBm
- PAE: 42%
- Power Supply: +8V/200mA
- Input/Output: 50Ω
- Die Size: 2.05 x 1.37 x 0.1 mm

Typical Applications

- Test Instrumentation
- Microwave Radio & VSAT
- Military & Space
- Telecom Infrastructure
- Fiber Optics

Electrical Specifications

TA = +25°C, Vd = +8V, Ids=200mA

Parameters	Min.	Typ.	Max.	Units
Frequency	8-12			GHz
Small Signal Gain	16	16.5	17	dB
Gain Flatness	±0.5			dB
Isolation		51		dB
P-1dB	31	31.5	-	dBm
Psat	31.5	32	-	dBm
PAE	-	42	-	%
Noise	-	6.5	-	dB
Input Return Loss	14	15	-	dB
Output Return Loss	9.5	11	-	dB

* Adjust VG (-2V-0V), Recommended gate voltage -0.85V.

Gain vs. Frequency

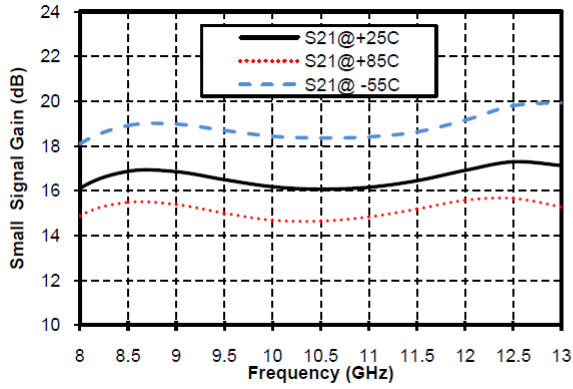

Input Return Loss vs. Frequency

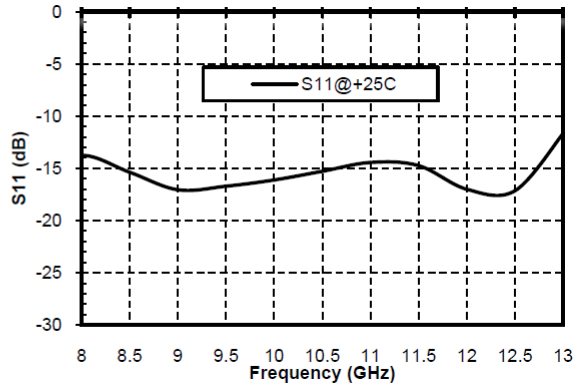

Output Return Loss vs. Frequency

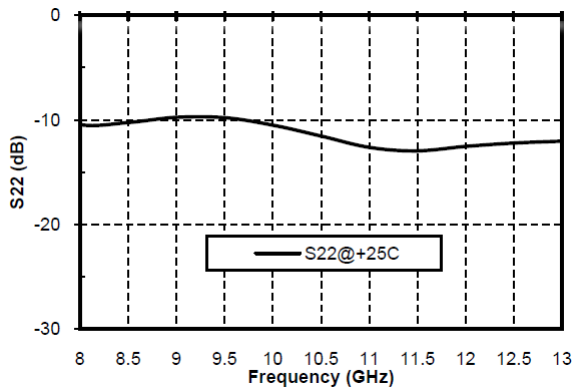

P-1dB vs. Frequency

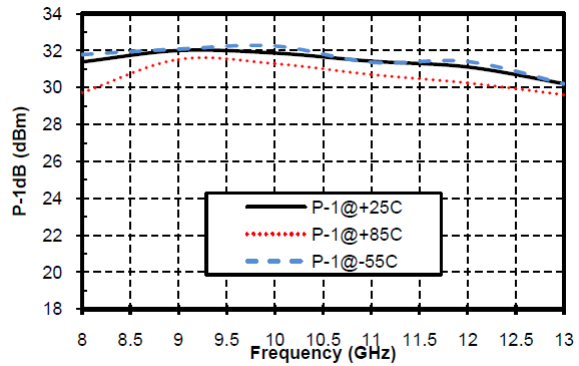

Psat vs. Frequency

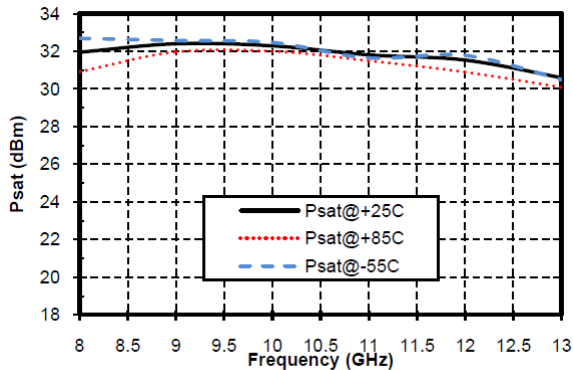

PAE vs. Frequency

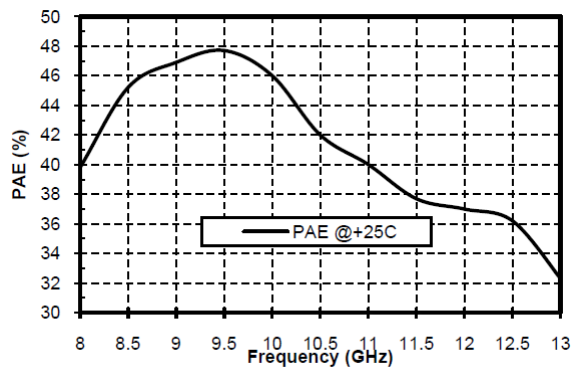



Outline Drawing: All Dimensions in μm

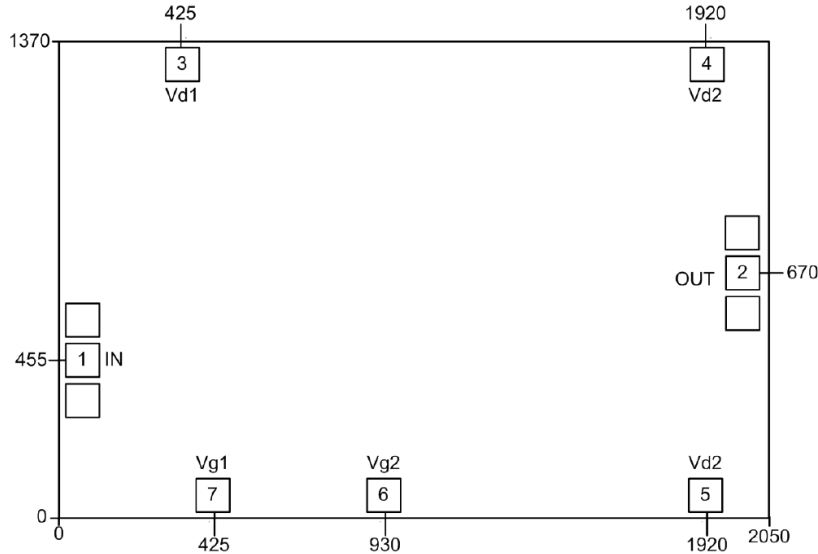

Pad Description

Pad	Function	Description
1	RF IN	Signal input terminal, connected to 50 Ω circuit; no blocking capacitor required.
2	RF OUT	Signal output terminal, connected to 50 Ω circuit; no blocking capacitor required.
3, 4, 5	VD1-2	Amplifier drain bias; external 100pF, 1000pF, 4.7uF bypass capacitor required.
6, 7	VG	Amplifier gate bias; external 100pF, 1000pF, 4.7uF bypass capacitor required.
Die bottom	GND	Die bottom must be connected to RF/DC ground.



Assembly Drawing

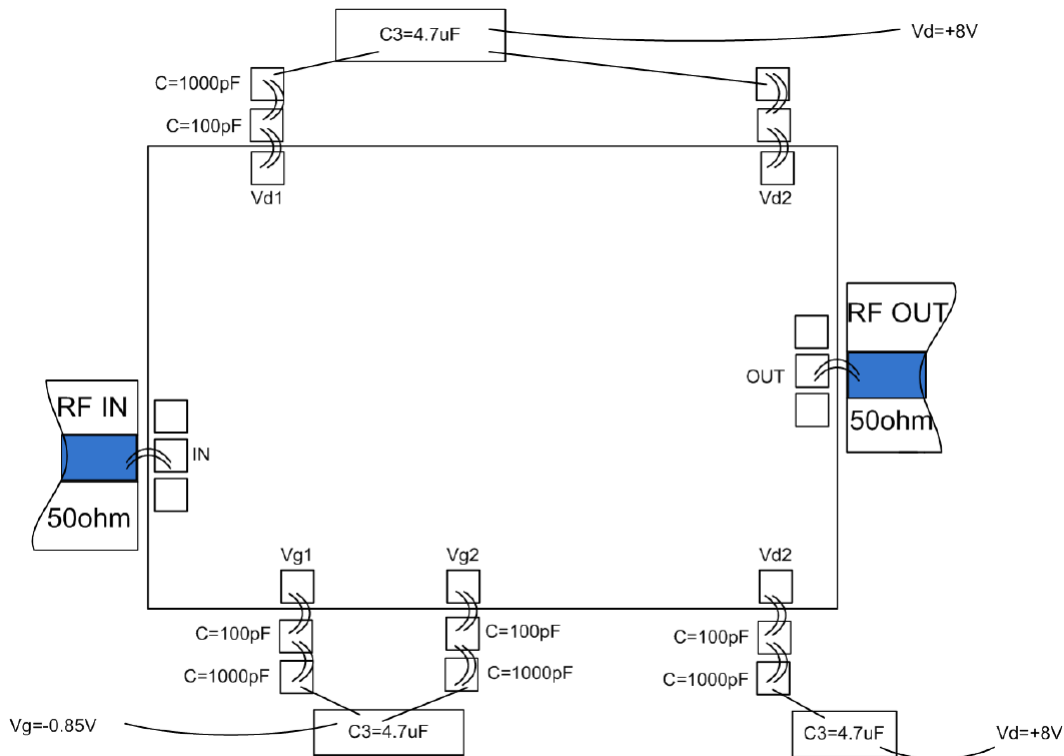

Notes:

1. Die thickness: 100um
2. Typical bond pad is 100*100 μm^2
3. Bond pad metalization: Gold
4. Backside metalization: Gold
5. Backside of the die (GND)
6. No connection required for unlabeled bond pads

Maximum Ratings:

1. Maximum drain voltage: +10V
2. Maximum gate bias: -3V
3. Maximum input power: +20dBm
4. Operating temperature: -55°C to +85°C
5. Storage temperature: -65°C to +150°C