



Features

- Frequency: 17-21GHz
- Small Signal Gain: 19dB
- P-1dB: 30dBm
- Psat: 30dBm
- Power Supply: +6V/400mA
- Input/Output: 50Ω
- Die Size: 2.6 x 1.22 x 0.1 mm

Typical Applications

- Test Instrumentation
- Microwave Radio & VSAT
- Military & Space
- Telecom Infrastructure
- Fiber Optics

Electrical Specifications

TA = +25°C, Vd = +6V, Vg=-0.9V, Ids=400mA

Parameters	Min.	Typ.	Max.	Units
Frequency	17-21			GHz
Small Signal Gain	17.5	19	21	dB
Gain Flatness	±1.75			dB
P-1dB	29	30	30.5	dBm
Psat	29	30	30.5	dBm
Input Return Loss	9	14	-	dB
Output Return Loss	20	23	-	dB
Quiescent Current		400		mA
* Adjust VG (-2V-0V), Recommended gate voltage -0.9V.				

Gain vs. Frequency

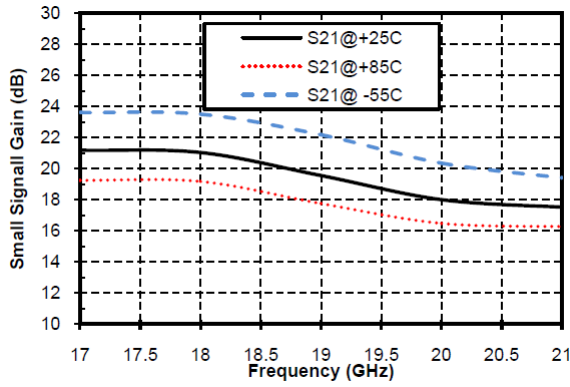

Isolation vs. Frequency

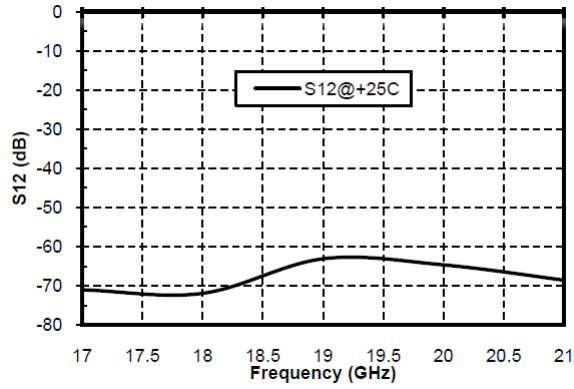

Input Return Loss vs. Frequency

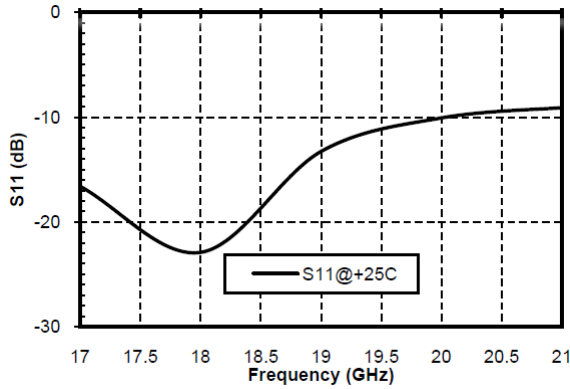

Output Return Loss vs. Frequency

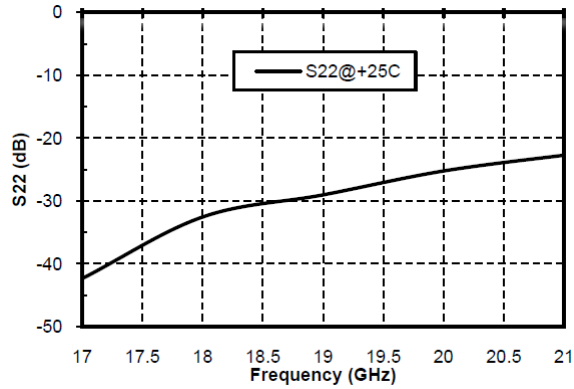

P-1dB vs. Frequency

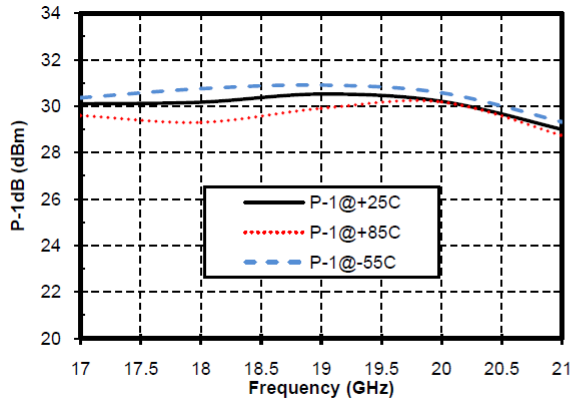

Psat vs. Frequency

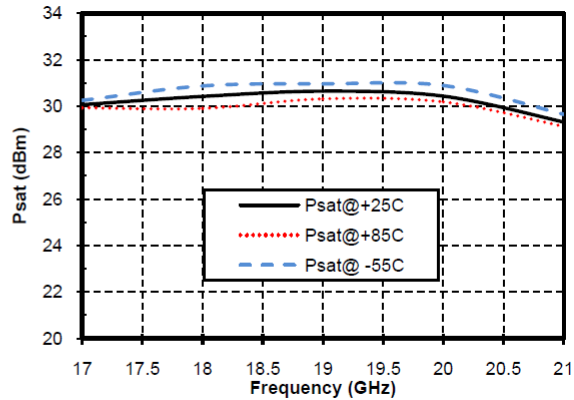



Outline Drawing:
All Dimensions in μm

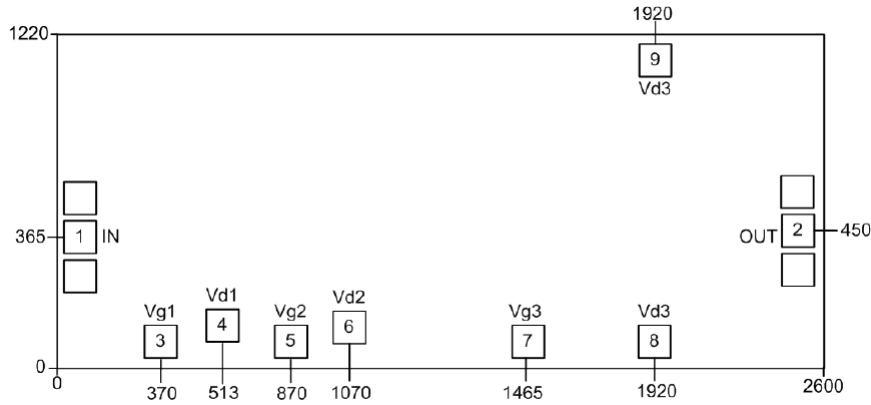

Pad Description

Pad	Function	Description
1	RF IN	Signal input terminal, connected to 50 Ω circuit; no blocking capacitor required.
2	RF OUT	Signal output terminal, connected to 50 Ω circuit; no blocking capacitor required.
4, 6, 8, 9	VD1-3	Amplifier drain bias; external 10pF, 1000pF bypass capacitor required.
3, 5, 7	VG1-3	Amplifier gate bias; external 10pF, 1000pF bypass capacitor required.
Die bottom	GND	Die bottom must be connected to RF/DC ground.



Assembly Drawing

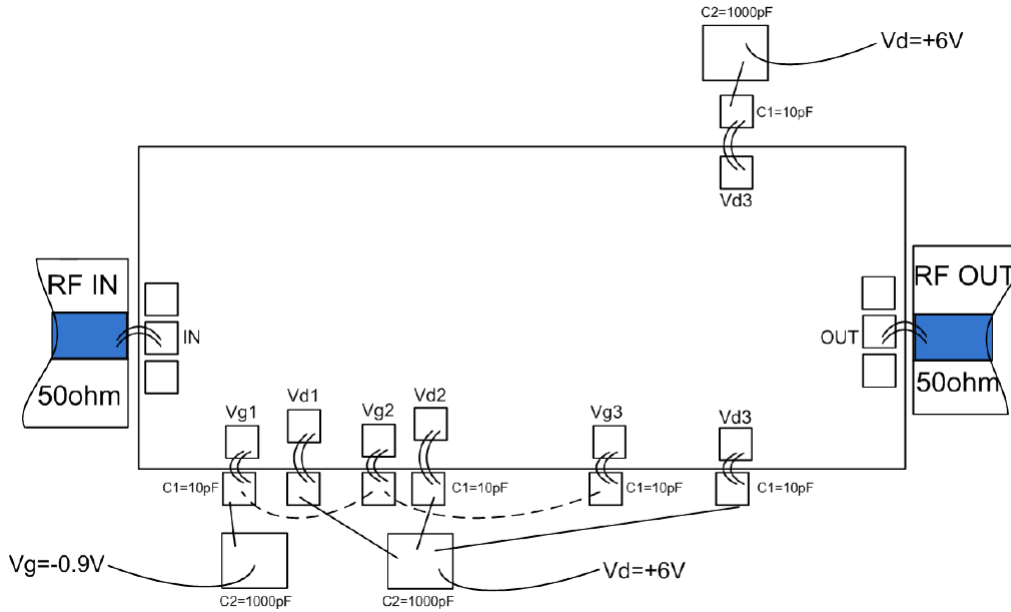

Note:

- C1 10pF
- C2 1000pF

Notes:

1. Die thickness: 100um
2. Typical bond pad is 100*100 μm^2
3. Bond pad metalization: Gold
4. Backside metalization: Gold
5. Backside of the die (GND)
6. No connection required for unlabeled bond pads

Maximum Ratings:

1. Maximum drain voltage: +8V
2. Maximum gate bias: -3V
3. Maximum input power: +25dBm
4. Operating temperature: -55°C to +85°C
5. Storage temperature: -65°C to +150°C