

Features

- Frequency: 0.1-40GHz
- Insertion Loss: 0.9dB typ.
- Isolation: 52dB typ.
- P-1dB: 26dBm
- Input/Output: 50Ω
- Die Size: 2.32x 0.87 x 0.1 mm

Typical Applications

- Test Instrumentation
- Microwave Radio & VSAT
- Military & Space
- Telecom Infrastructure
- Fiber Optics

Electrical Specifications
TA = +25°C

Parameters	Min.	Typ.	Max.	Units
Frequency Range	0.1-18			GHz
Insertion Loss	-	0.7	0.8	dB
Isolation	50	58	-	dB
Input Return Loss	17	19	-	dB
Output Return Loss	22	25	-	dB
Frequency Range	18-40			GHz
Insertion Loss	-	1.0	1.1	dB
Isolation	46	48	-	dB
Input Return Loss	16	20	-	dB
Output Return Loss	12	17	-	dB
P-1dB	-	26	-	dBm
Switching Speed	-	20	-	ns

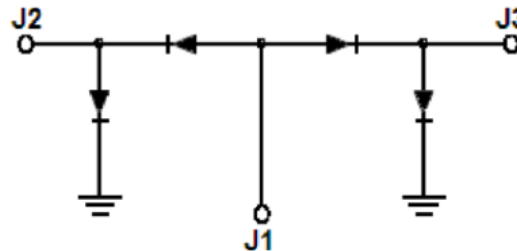
Functional Block Diagram

Insertion Loss vs. Operating Frequency

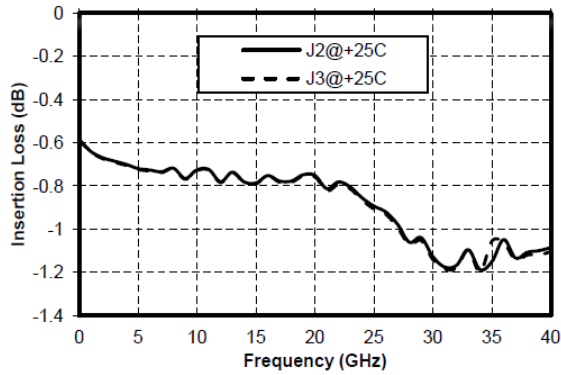

Isolation vs. Operating Frequency

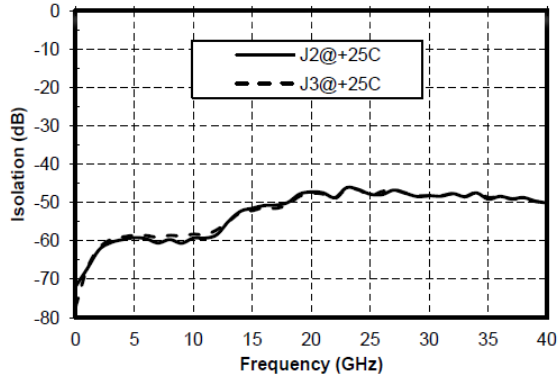

Input Return Loss vs. Operating Frequency

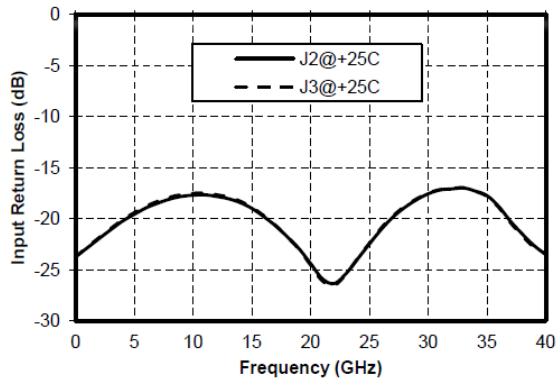

Output Return Loss vs. Operating Frequency

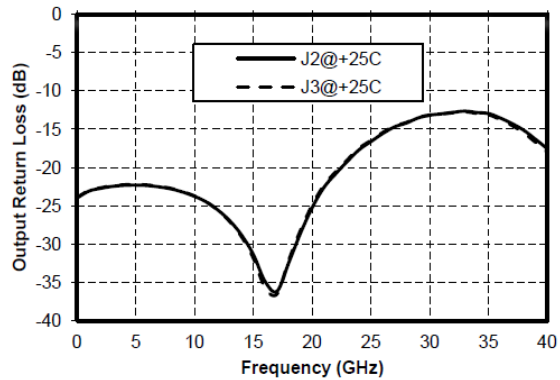

Typical Driver Connections

CONTROL LEVEL (DC CURRENT)		RF OUTPUT STATE	
OUT1(J2)	OUT2(J3)	OUT1(J2)-IN(J1)	OUT2(J3)-IN(J1)
-10mA	+10mA	Low Loss	Isolation
+10mA	-10mA	Isolation	Low Loss



Outline Drawing

All Dimensions in μm

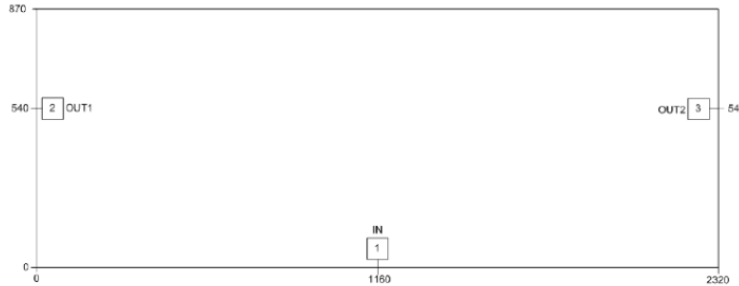

Pad Description

Pad	Function	Description
1	IN (J1)	RF signal input port
2,3	OUT2 (J2), OUT3 (J3)	RF signal output port
Die bottom	GND	Die bottom must be connected to RF/DC ground.

Assembly Drawing

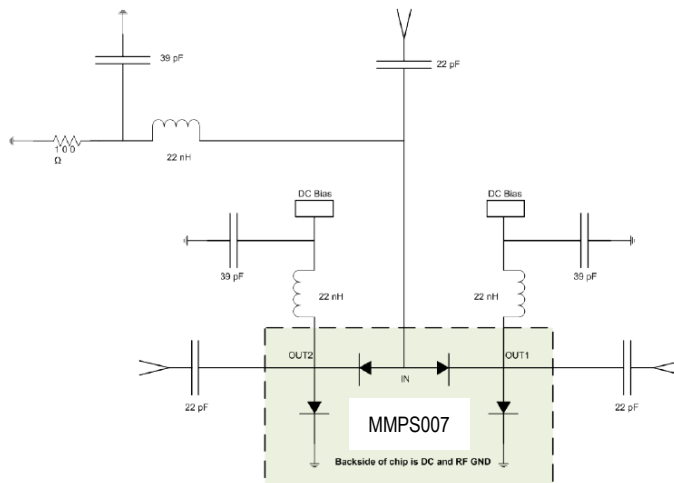

Notes:

1. Die thickness: 100 μm
2. Typical bond pad is 100*100 μm^2
3. Bond pad metalization: Gold
4. Backside metalization: Gold
5. Backside of the die (GND)
6. No connection required for unlabeled bond pads

Maximum Ratings:

1. Maximum input voltage: 25V
2. Maximum input power: +31dBm CW
3. Operating temperature: -55 $^{\circ}\text{C}$ to +85 $^{\circ}\text{C}$
4. Storage temperature: -65 $^{\circ}\text{C}$ to +150 $^{\circ}\text{C}$