

Features

- Frequency: 2-20GHz
- Insertion Loss: 0.9dB typ.
- Isolation: 49dB typ.
- P-1dB: 25dBm
- Input/Output: 50Ω
- Die Size: 2.17x 1.62x 0.1 mm

Typical Applications

- Test Instrumentation
- Microwave Radio & VSAT
- Military & Space
- Telecom Infrastructure
- Fiber Optics

Electrical Specifications
TA = +25°C

Parameters	Min.	Typ.	Max.	Units
Frequency Range	2-20			GHz
Insertion Loss	-	0.9	1.2	dB
Isolation	42	49	-	dB
Input Return Loss	15	17	-	dB
Output Return Loss	18	26	-	dB
P-1dB	-	25	-	dBm
Switching Speed	-	20	-	ns

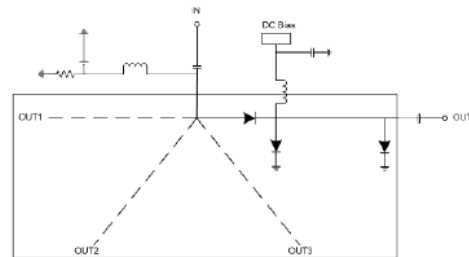
Functional Block Diagram

Insertion Loss vs. Operating Frequency

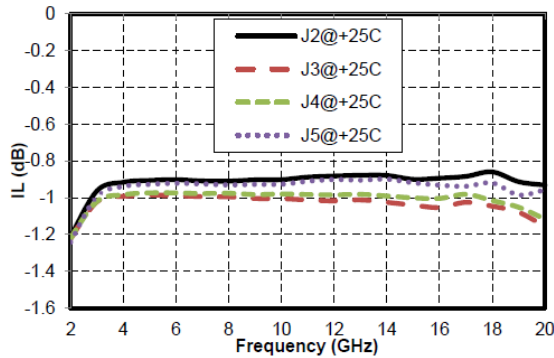

Isolation vs. Operating Frequency

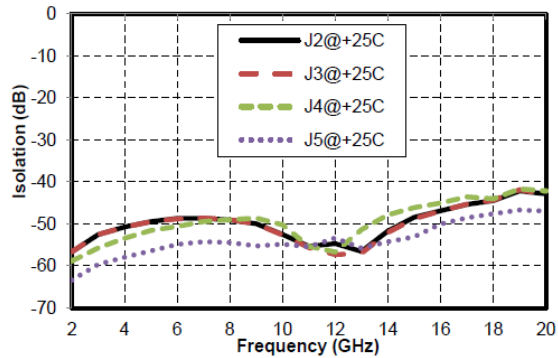

Input Return Loss vs. Operating Frequency

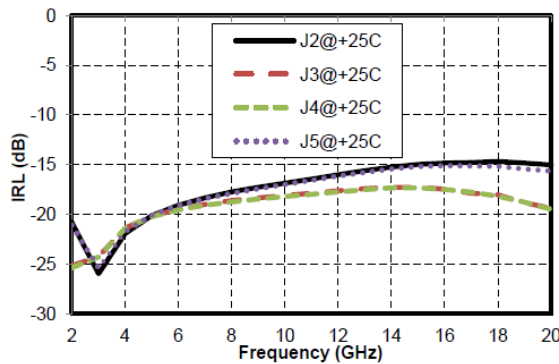

Output Return Loss vs. Operating Frequency

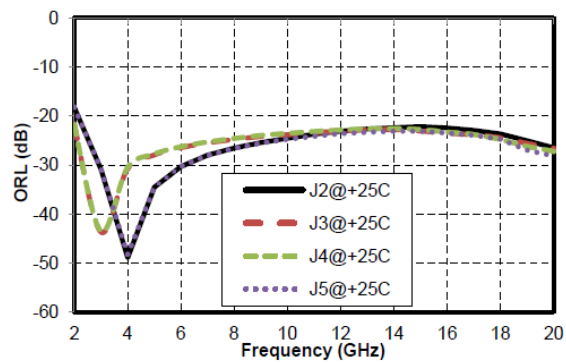

Typical Driver Connections

CONTROL LEVEL (DC CURRENT)				RF OUTPUT STATE			
VC1	VC2	VC3	VC4	J2-J1	J3-J1	J4-J1	J5-J1
-10mA	+10mA	+10mA	+10mA	Low Loss	Isolation	Isolation	Isolation
+10mA	-10mA	+10mA	+10mA	Isolation	Low Loss	Isolation	Isolation
+10mA	+10mA	-10mA	+10mA	Isolation	Isolation	Low Loss	Isolation
+10mA	+10mA	+10mA	-10mA	Isolation	Isolation	Isolation	Low Loss



Outline Drawing

All Dimensions in μm

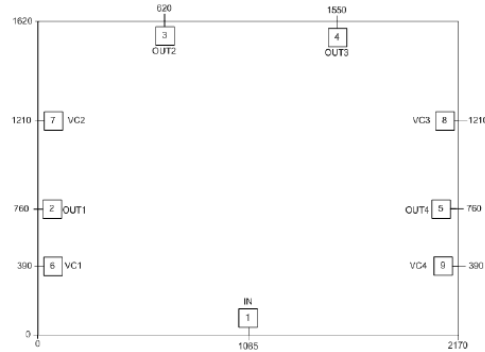

Pad Description

Pad	Function	Description
1	IN(J1)	RF signal input port
2,3,4,5	OUT1(J2), OUT2(J3), OUT3(J4), OUT4(J5)	RF signal output port
6,7,8,9	VC1, VC2, VC3, VC4	Signal control port
Die bottom	GND	Die bottom must be connected to RF/DC ground.

Assembly Drawing

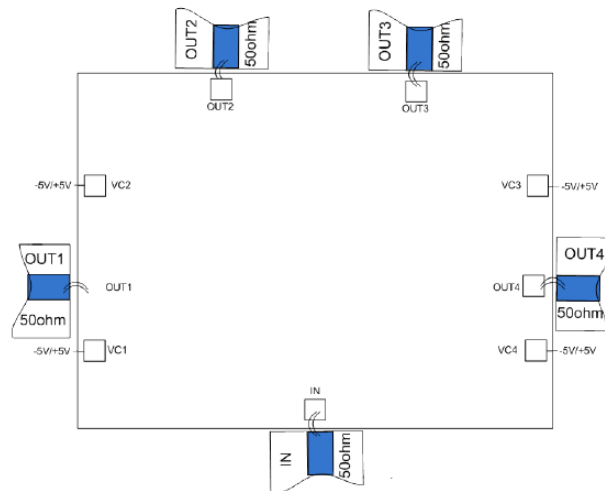

Notes:

1. Die thickness: 100 μm
2. Typical bond pad is 100*100 μm^2
3. Bond pad metalization: Gold
4. Backside metalization: Gold
5. Backside of the die (GND)
6. No connection required for unlabeled bond pads

Maximum Ratings:

1. Maximum input voltage: 25V
2. Maximum input power: +31dBm CW
3. Operating temperature: -55 $^{\circ}\text{C}$ to +85 $^{\circ}\text{C}$
4. Storage temperature: -65 $^{\circ}\text{C}$ to +150 $^{\circ}\text{C}$